

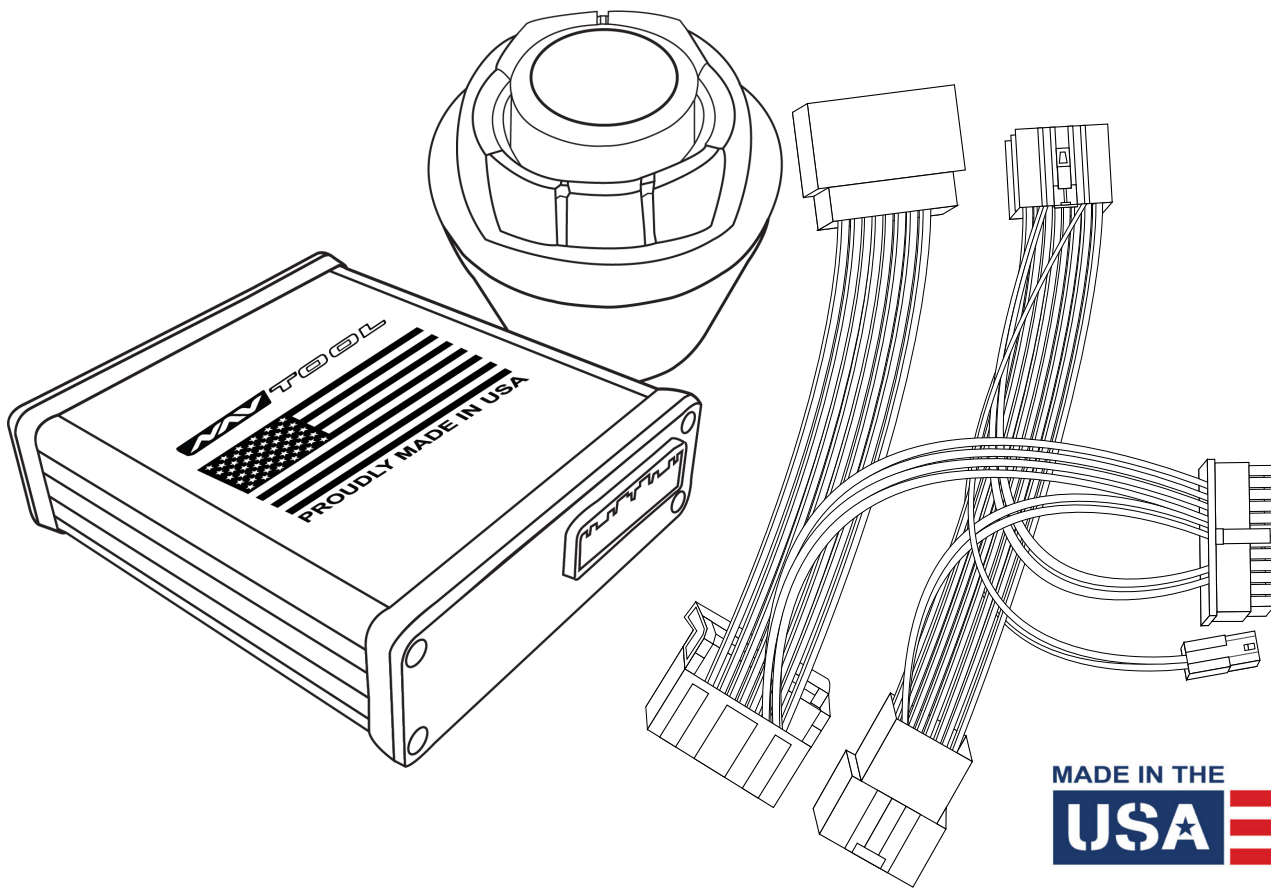

Installation Manual

Chevrolet Avalanche 2012-2013

Must be equipped with factory rear view camera



Interface with Apple CarPlay and Android Auto Part #: NAVTOOL6.0-AR2-NBT

*NOTICE: Navtool recommends having this installation performed by a certified technician.
Logos and trademarks used here in are the properties of their respective owners.*

WELCOME

IMPORTANT WARNING

This product includes instructions for installation, which must be carefully followed. The instructions are worded in such a manner to assume that the installer is capable of completing these types of electronic installations. Suppose you are unclear about what you are instructed to do or believe you do not understand the instructions to complete the installation properly and safely. In that case, you should consult a technician who has this knowledge and understanding. Failure to follow these instructions carefully and install the interface as described could cause harm to the vehicle or safety systems on the vehicle. Interference with specific safety systems could cause damage to persons as well.



NEED HELP?



Open the camera app on your smartphone and point your rear camera at the QR-Code to scan it. Finally, tap the pop up banner to open support website.

Table of Contents

Installation Instructions

Precautions	3
What's In The Box	4
Interface Connectors Description	5
Universal Harness Description	6
Quick Connection Guide	7
Installation Instructions	8-12
Testing and Settings	13-17

Extra Details

Vehicle Reassembly Checklist	18
Apple CarPlay/Android Auto Menus	19-31
Video Interface Menus	32-37
Connect Rear Screens With AV Input	38
Connect Rear Screens With HDMI Input	39

User Manual

User Manual for Consumers	C1-C5
---	-------

Print pages C1-C5 and give them to the customer

Precautions

PLEASE READ BEFORE YOU START THE INSTALLATION

- Please study these instructions carefully before installing NavTool interface.
- Many new vehicles use low-voltage or data-bus systems that can be damaged by test lights and logic probes. Test all circuits with a digital multi-meter before making connections.
- Do not disconnect the battery if the vehicle has an anti-theft-coded radio, unless you have the radio code.
- If installing an external push button switch, check with the customer about where to install the switch.
- To avoid accidental battery drainage turn off the interior lights or remove the dome light fuse.
- Roll down a window to avoid being locked out of the car.
- Use of this product in a manner different to its intended way of operation may result in property damage, personal injury, or death.
- Set Parking brake.
- Remove the negative battery cable.
- Protect fenders before starting.
- Using protective blankets to cover front seats, interior of the vehicle and center console.
- Always install a fuse 6-12 inches away from NavTool interface, 5 amp fuse should be used.
- Always secure NavTool interface with Velcro or double side tape to prevent rattling of the interface.
- When securing NavTool interface make sure that panels can be closed back easily.
- Use electrical tape on all you connections and splices, do not leave any exposed connections.
- Route all wires along factory harnesses, try not to drill or make any unnecessary holes.
- Make sure you are not connecting to any data wires; always check your connections with a multi-meter.
- Always use help of a professional installer to prevent any damage to the vehicle or NavTool interface.

What's In The Box?

NavTool Interface
(Part # NAVTOOL6.0-AR2-NBT)

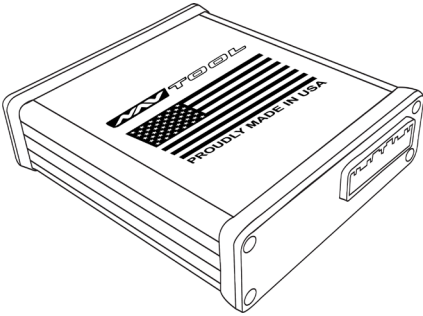

NavTool Joystick
(Part # NT-JY1)

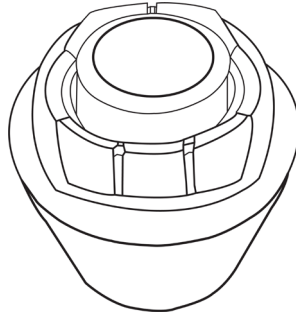

Joystick Receiver
(Part # NT-JYRCV1)

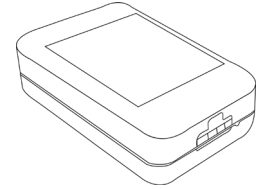

NavTool Interface Harness
(Part # NT-WHNT6)

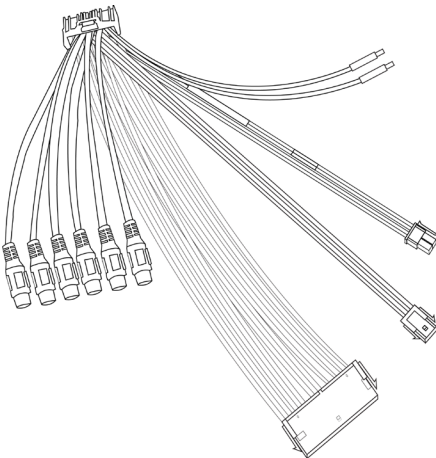

Vehicle Specific
Plug and Play Harness
(Part # NT-GMQUAD1)

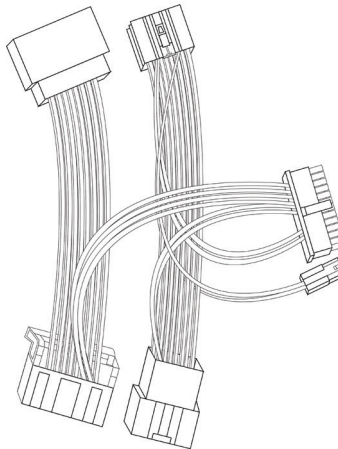

Joystick Receiver Cable
(Part # NT-JYRB1)

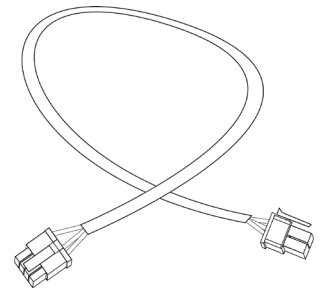

USB Configuration Cable
(Part # NT-USB-CNG)

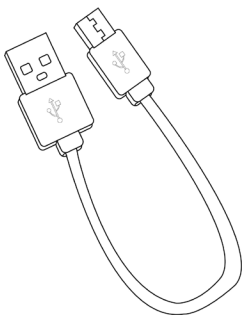

Batteries
(Part # NT-BT-AAA)

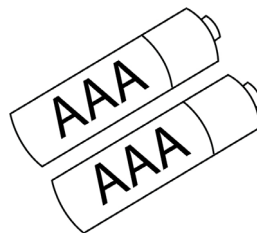

Interface Connectors Description

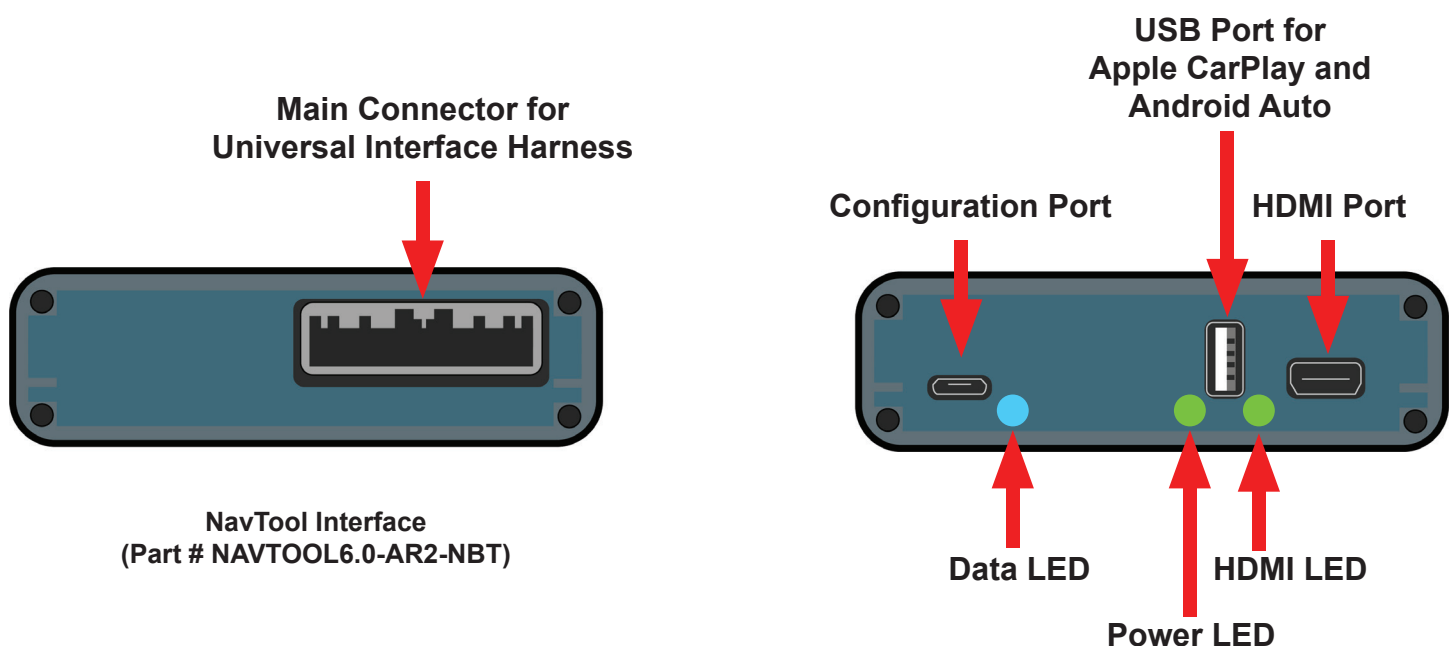

Main Connector for Universal Interface Harness- This port is dedicated for a connection of a universal wiring harness.

Configuration Port- This USB port is dedicated for the interface configuration only.

Data LED- Normal operation of the interface must have blue LED blinking. If the blue LED is not blinking, the interface is not receiving data from the vehicle. If the blue LED is not blinking, the interface will not operate properly.

Power LED- Normal operation of the interface must have a green LED ON. If the green LED is not ON, the interface is not receiving power. If the green LED is not ON, the interface will not work, and your vehicle radio may also stay OFF.

HDMI LED- Normal operation of the interface must have a green LED ON. If the green LED is not ON, the interface HDMI is not receiving power. If the green LED is not ON, the interface HDMI port will not work.

USB Port for Apple CarPlay and Android Auto- This USB port is for hard-wire connection of a smartphone if you want your iPhone or Android hard-wired to the interface instead of a wireless connection. This USB port also provides charging for your smartphone. This connection is not required if you plan to use Apple CarPlay and Android Auto via the wireless connection. Do not use this USB port to power up HDMI streaming devices such as Roku, FireStick, Chromecast, or similar devices.

HDMI Port- HDMI port is dedicated for connecting video sources such as iPhone mirroring, Android Mirroring, Apple TV, Roku, FireStick, Chromecast, PlayStation, Xbox, or similar devices.

Universal Harness Description

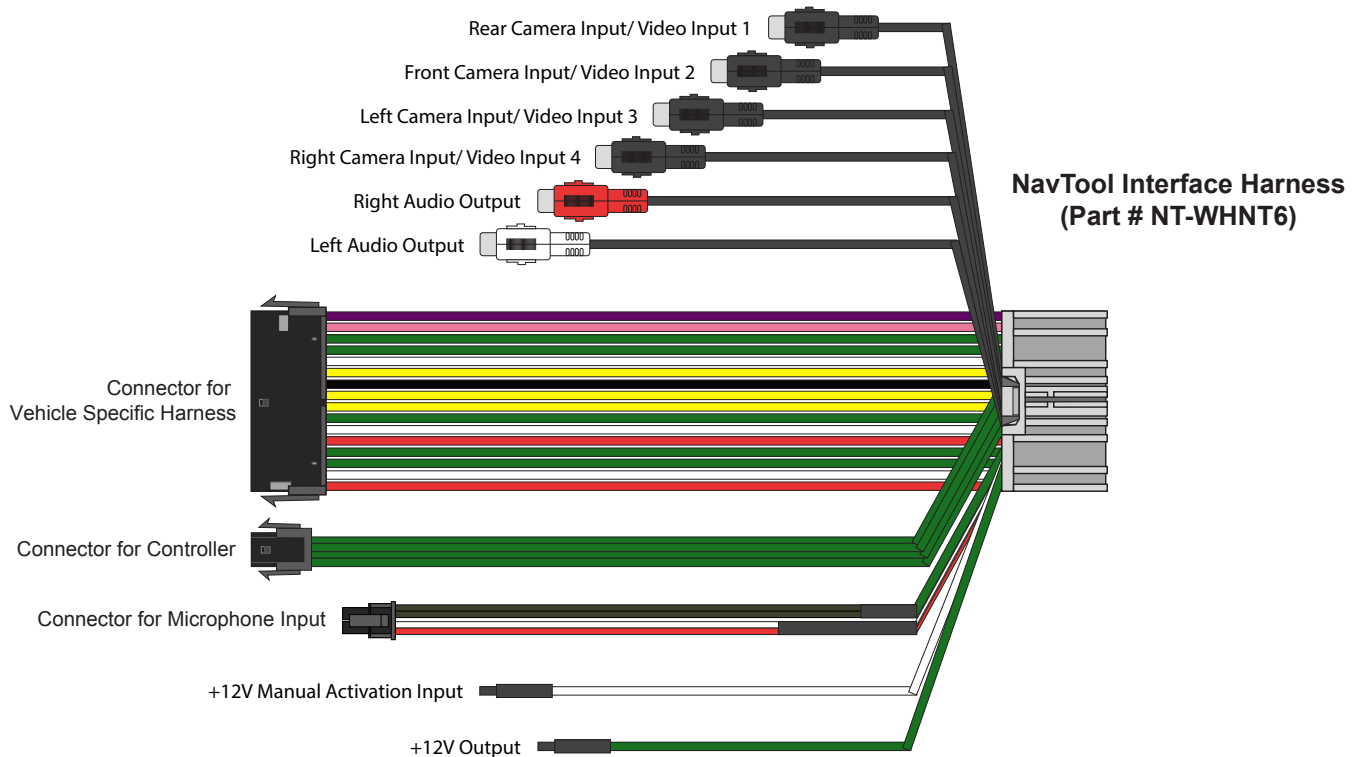

Rear Camera Input /Video Input 1- This input is dedicated for an aftermarket rearview camera or a video source with an RCA video output. Your vehicle factory camera will continue to work as before without any changes.

Front Camera Input /Video Input 2- This input is dedicated for an aftermarket front view camera or a video source with an RCA video output. Your vehicle factory camera will continue to work as before without any changes.

Left Camera Input / Video Input 3- This input is dedicated for an aftermarket left view camera or a video source with an RCA video output. Your vehicle factory camera will continue to work as before without any changes.

Right Camera Input / Video Input 4- This input is dedicated for an aftermarket right view camera or a video source with an RCA video output. Your vehicle factory camera will continue to work as before without any changes.

Right and Left Audio Output- Audio output is dedicated for connecting audio to your vehicle's stereo system. See the Quick Connection Guide on page 7 of this manual.

Connector for Vehicle Specific Harness- This connection is dedicated for connecting vehicle specific plug and play wiring harness.

Connector to Controller- This connection is dedicated for a connection of an external controller. See the quick connection guide on page 7 of this manual.

Connector for Microphone Input- This connection is dedicated for connecting a built-in vehicle microphone. See the quick connection guide on page 7 of this manual.

+12V Manual Activation Input- This connection is used only if the factory rearview camera is not operating correctly in reverse. In that case, this wire must be connected to the vehicle's reverse +12V output.

+12V Output- 500 mA output can be used to drive a relay. This output provides +12V at all times when the vehicle is running.

Installation Instructions

STEP 1

NO APPLICATION OR SOFTWARE DOWNLOAD IS REQUIRED TO CONFIGURE THE INTERFACE.

To configure the interface, you must use Windows, Mac, or Google computer.

Windows computers must use the latest version of Google Chrome or Microsoft Edge browser.

Mac computers must use the latest version of the Google Chrome browser.

Google computers must use the latest version of the Google Chrome browser.

TO CONFIGURE THE INTERFACE, GO TO [HTTPS://CONFIG.NAVTOOL.COM](https://config.navtool.com)

Connect the interface to the computer using supplied USB Configuration Cable (Part # NT-USB-CNG)

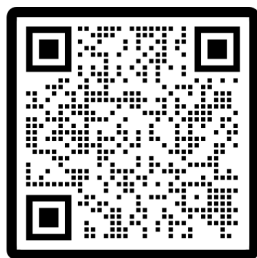
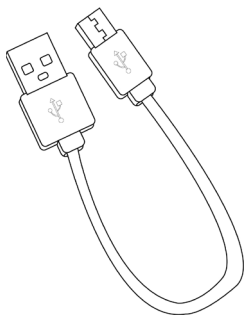

SCAN ME

To see a video of the configuration process
Scan QR-Code or go to
https://youtu.be/iES_rW240X0

STEP 2

Remove Vehicle Navigation Radio or Color Screen

List of Required Tools:

1. Plastic Panel Removal Tool- Example of a removal tool is shown below. Any similar removal tool will do the job. It does not need to be the same as the picture below.
2. 7 mm Socket- Example of a 7 mm socket tool is shown below. Any similar tool will do the job. It does not need to be the same as the picture below.



Installation Instructions

STEP 2 Continued

Step 1:

- Use a flat-bladed plastic trim tool in order to release the retainer clips securing the trim plate to the instrument panel.
- Retainer Clips (Qty: 9)

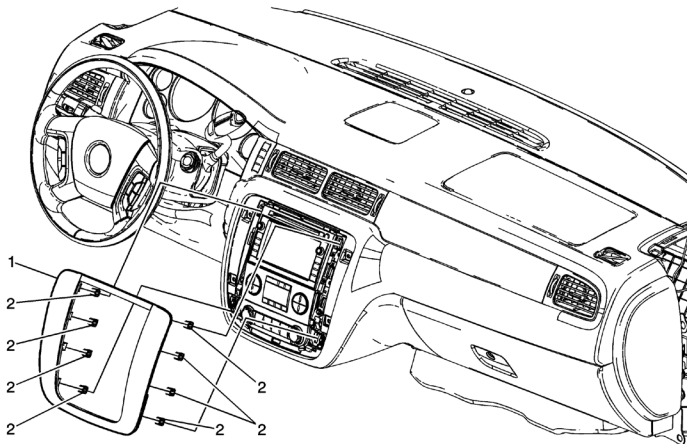

Step 2:

- Instrument Panel Accessory Switch Screw (Qty: 2)
- Disconnect the electrical connections.

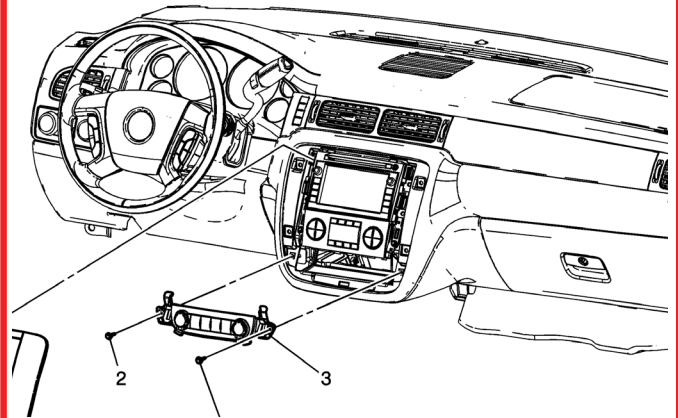

Step 3:

- Heater and Air Conditioning Control Assembly Screw (Qty: 2)

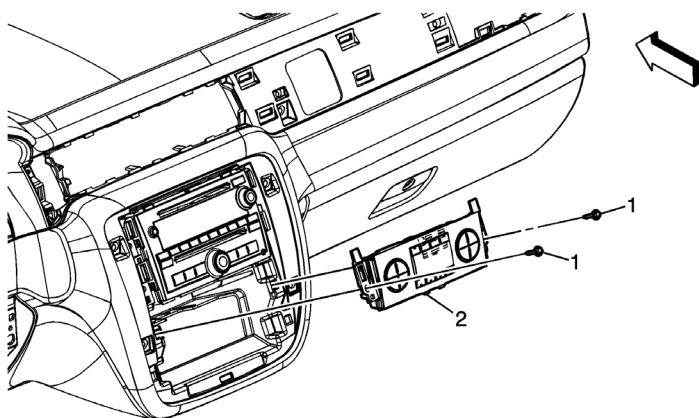

Step 4:

- Radio Screw (Qty: 4)
- Disconnect the electrical connector.
- Disconnect the antenna cable.

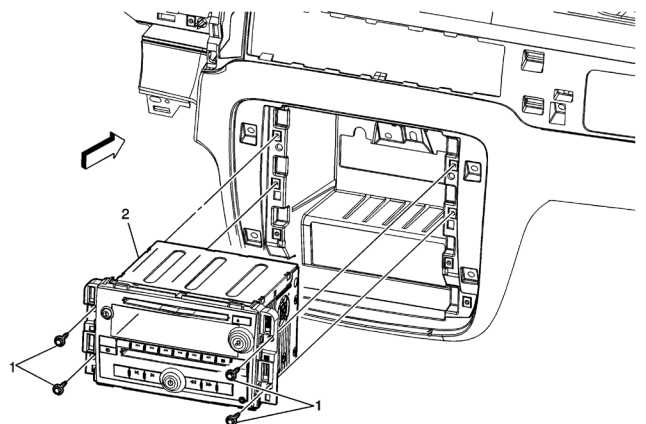

Installation Instructions

STEP 3

Step 1: Connect supplied plug and play harness (Part # NT-GMQUAD1) to the back of the radio.

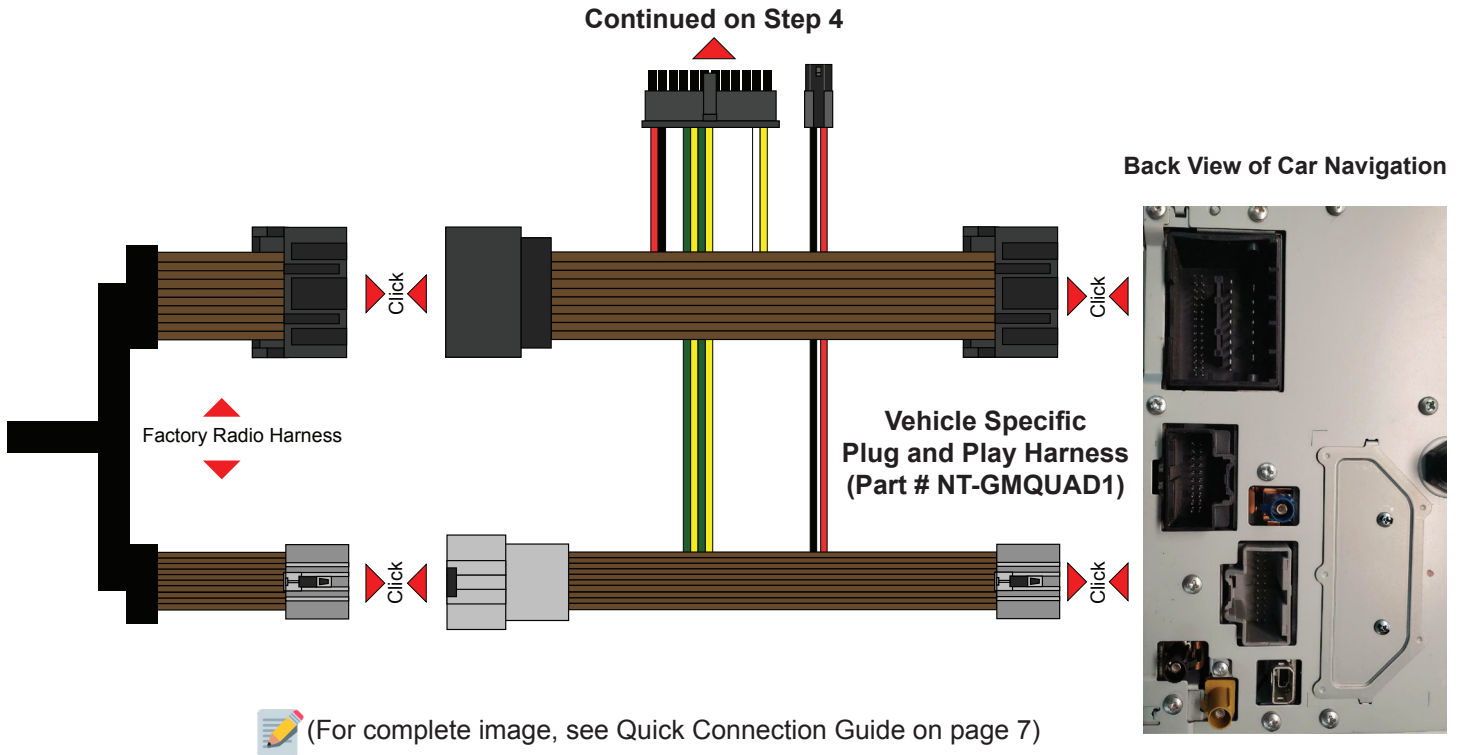

Step 2: ⚠️ Reconnect previously removed radio connectors into the back of the radio.

STEP 4

Connect supplied universal wiring harness (Part # NT-WHNT6) into plug and play harness (Part # NT-GMQUAD1).

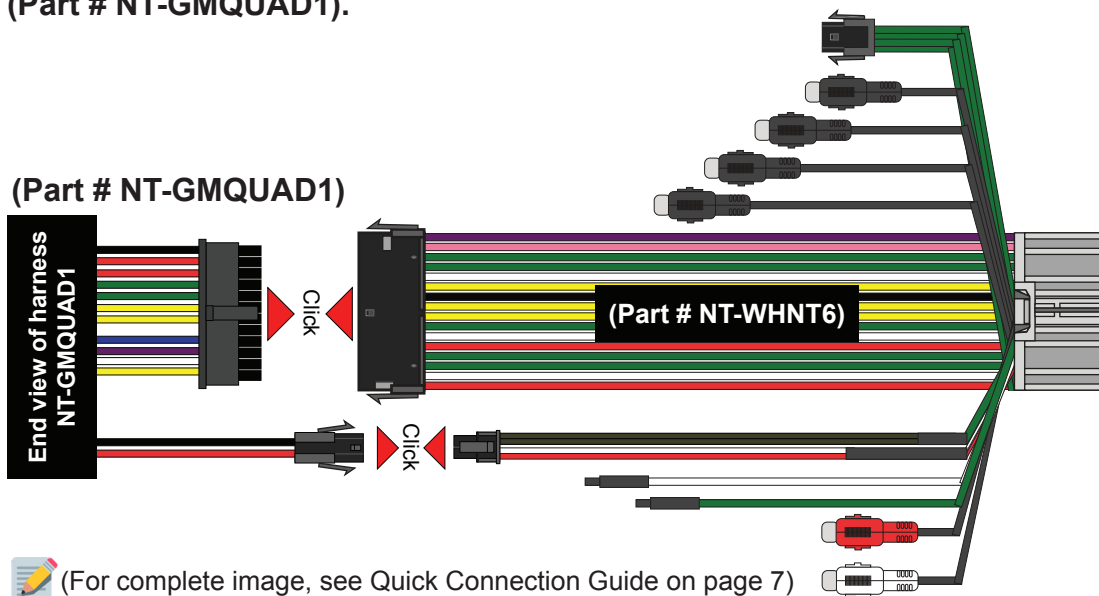

Installation Instructions

STEP 5

Step 1: Connect supplied joystick receiver harness (Part # NT-JYRB1) into 4 pin connector on the universal wiring harness (Part # NT-WHNT6). See quick connection guide on page 7.

Step 2: Connect supplied joystick receiver (Part # NT-JYCV1) into joystick receiver harness (Part # NT-JYRB1). See quick connection guide on page 7.

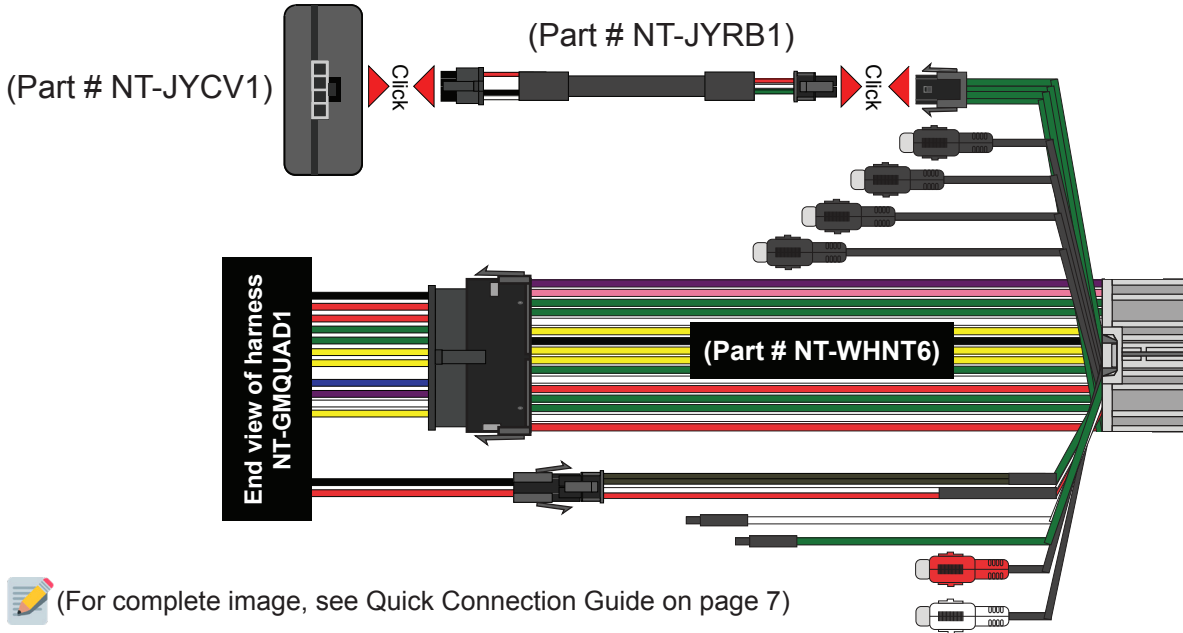

STEP 6

Connect audio output on the universal wiring harness (Part # NT-WHNT6) RCA plugs into the vehicle's AUX input using appropriate cables. See quick connection guide on page 7.

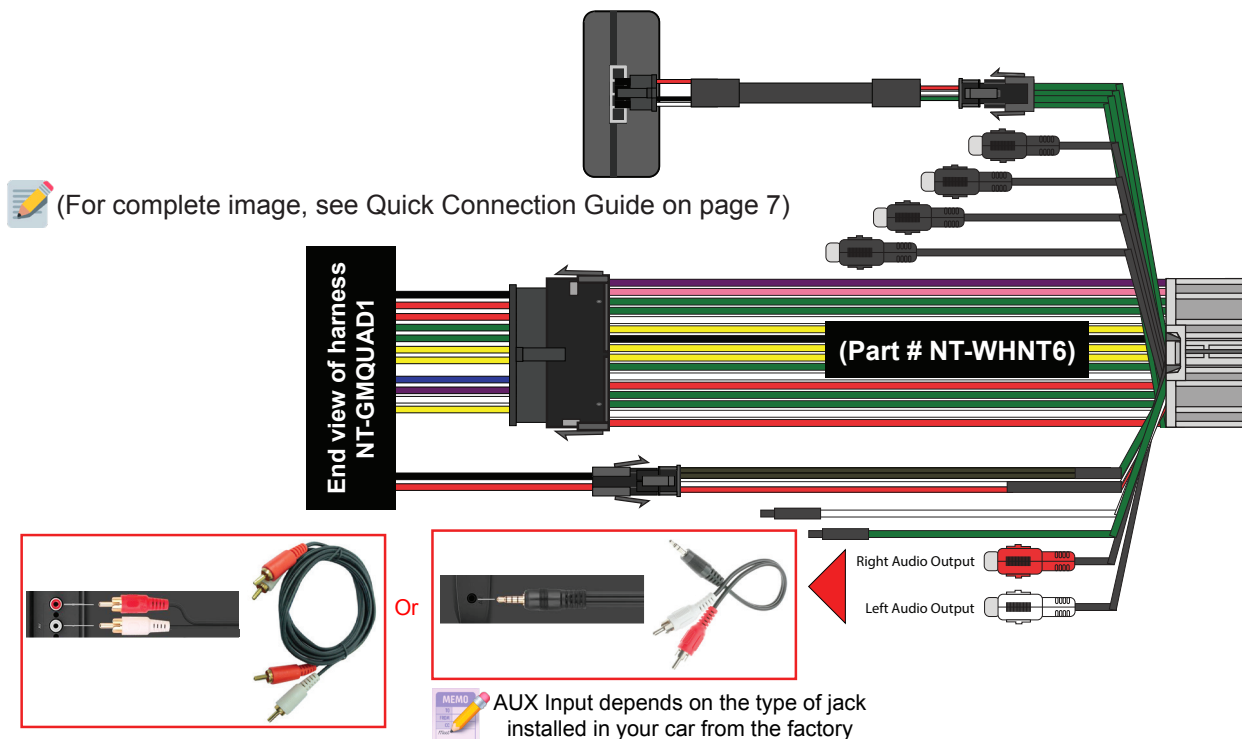

Installation Instructions

STEP 7

Plug in main interface (Part # NAVTOOL6.0-AR2-NBT) into the universal wiring harness (Part # NT-WHNT6). See quick connection guide on page 7.

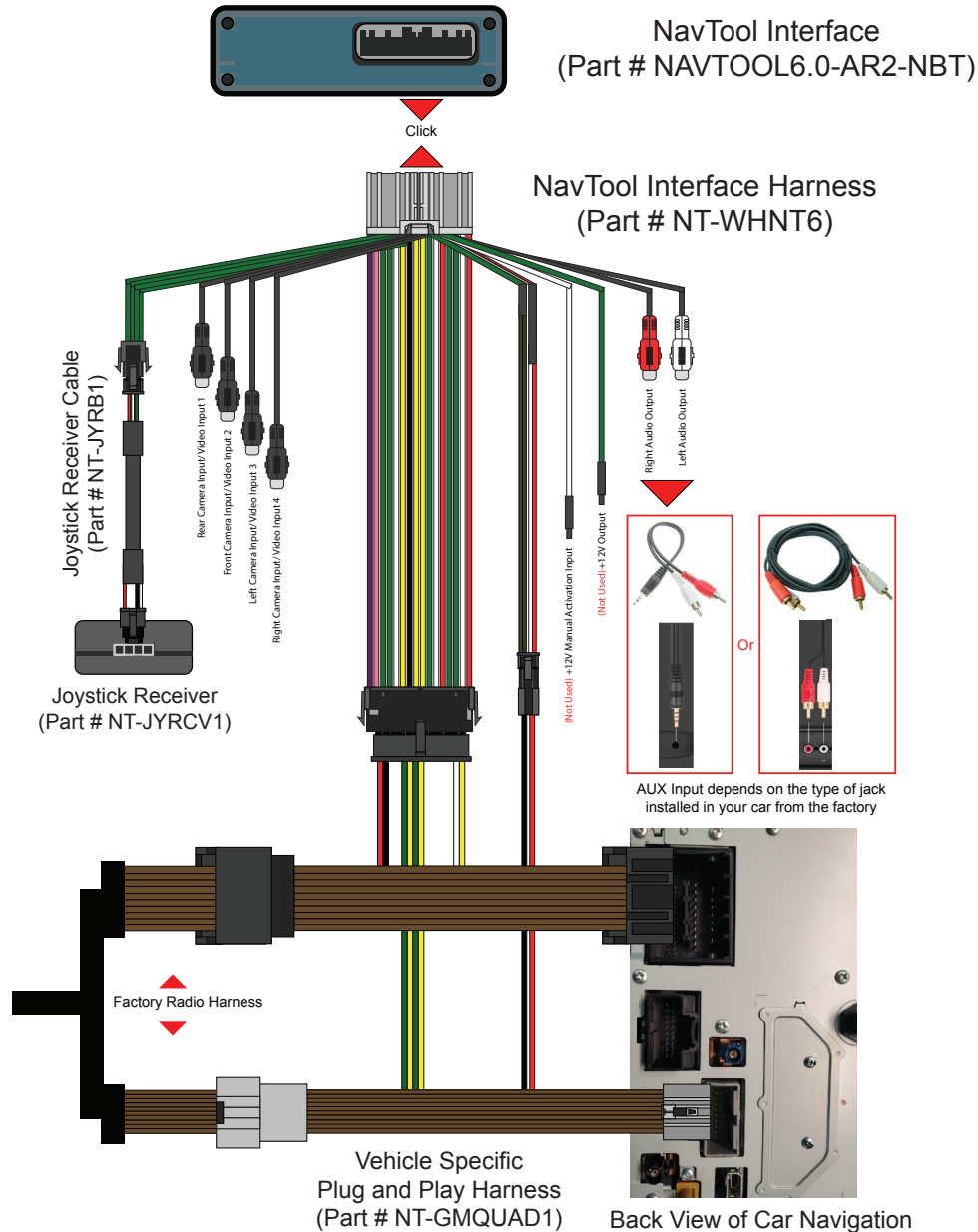

- The product installation is now complete.
- Do not reassemble the vehicle until testing is fully complete. Only after you have tested that everything is working can you reassemble the car.
- If you are adding side or front cameras, install them and plug them into the appropriate camera RCAs.
- If you are installing any HDMI or streaming devices, connect it to the HDMI port of the NavTool.

Testing and Settings

STEP 1

- Start the car, observe NavTool LED lights should be one blinking blue and two steady lit green LED lights.

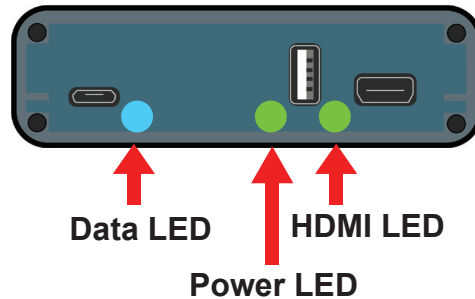

- At this time, your car radio should boot up into its initial state, and the radio should be working. Please check that the radio operates appropriately. All radio functions are working, including CD, Satellite Radio, AM/FM radio, audio plays from car speakers, and all other radio features.

STEP 2

Turn off camera lines in the settings of your factory navigation. Go into display settings of the factory radio/navigation, then go into Rear Camera Options and then turn off Guiding Lines.

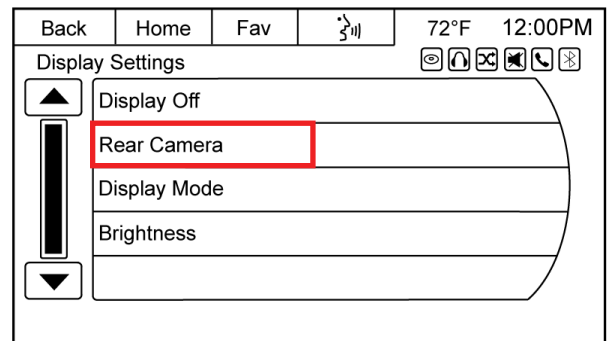
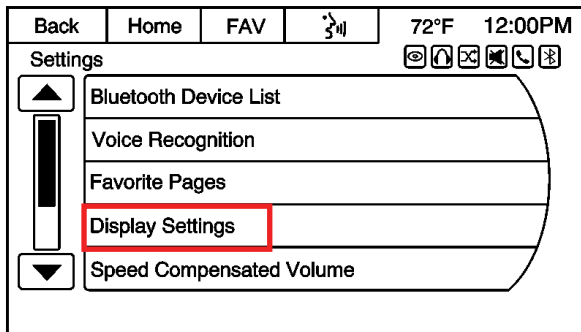

STEP 3



Set Radio to AUX Audio Input:

- SRCE Button: Press the SRCE button to display the audio screen. Press to switch between AM, FM, or XM, if equipped, Disc, or AUX (Auxiliary). Must set a radio to auxiliary/AUX before activating NavTool to hear audio from car speakers. See page 11 step 6 for AUX connection.
- Audio will not play through car speakers if AUX input is not connected or radio is not set to AUX input.

Testing and Settings

STEP 4

- On the supplied joystick remote (Fig. 1), press and hold the back button for 3-5 seconds. The interface should emit a chirp and the interface menu (Fig. 2) should appear on the screen.

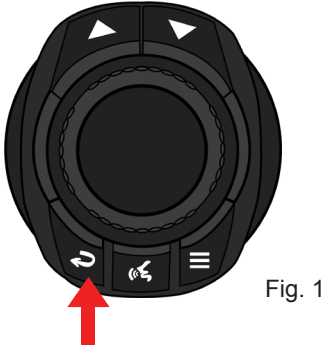

Fig. 1

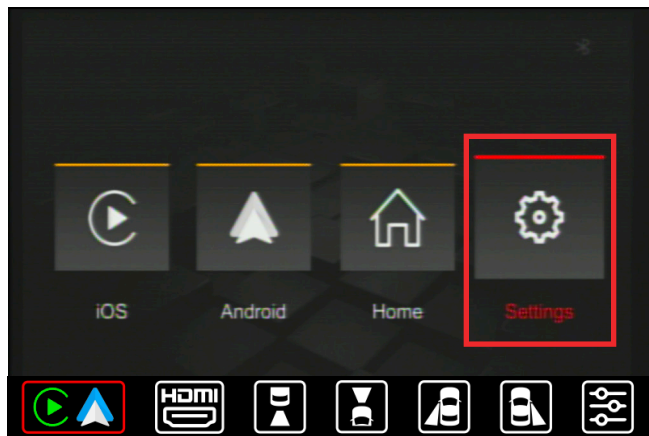

Fig. 2

STEP 5

- Turn ON factory microphone feature in the Apple CarPlay/Android Auto settings.

Step 1:



Press enter button on the supplied joystick remote to enter the Apple CarPlay/Android Auto mode, then rotate joystick to the right to highlight settings then press enter button on the supplied joystick remote to enter the settings.

Step 2:

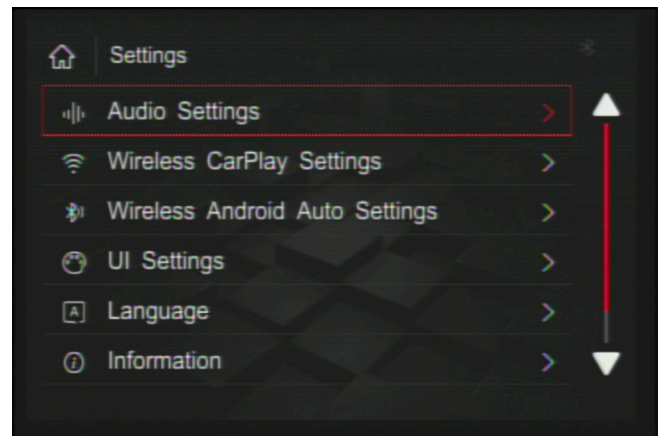

You should now see the settings screen above. Press enter button on the supplied joystick remote to enter the audio settings.

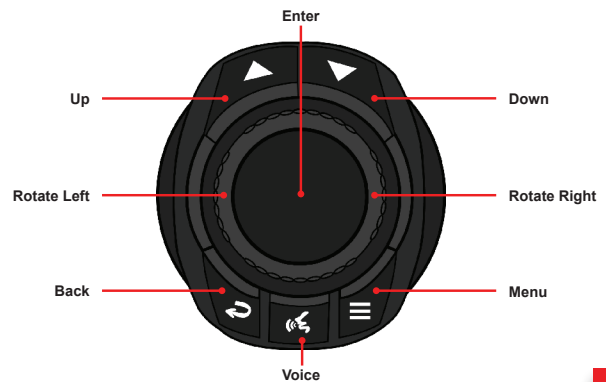

Testing and Settings

STEP 6

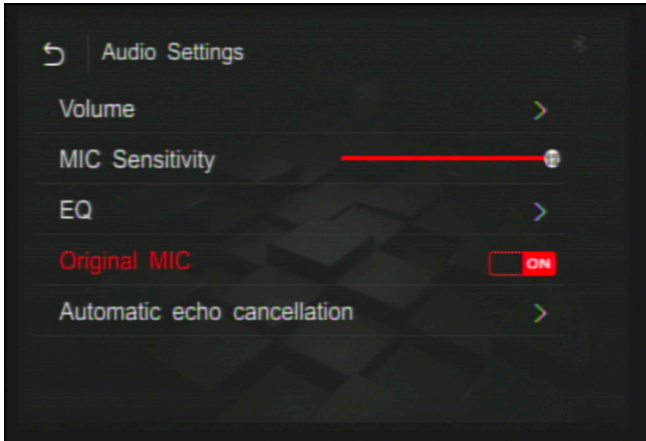

Audio Settings- Original MIC ON

- Rotate the joystick to highlight Original MIC feature.
- Press enter button on joystick to change this option.

STEP 7

Adjust camera inputs if you haven't done so already during the initial configuration of the interface.

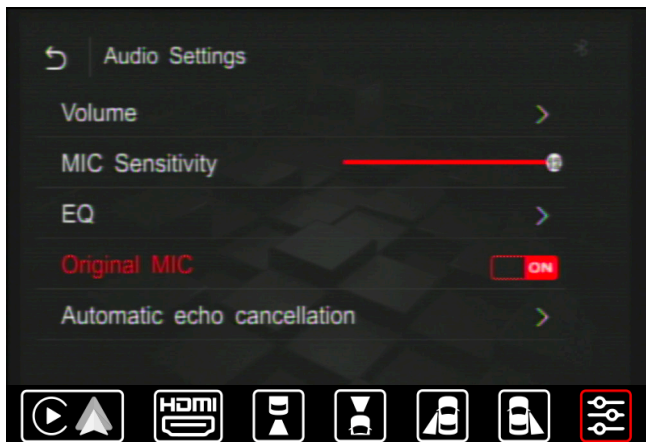

- Press menu button on the remote control to reveal NavTool menu bar.
- Rotate joystick to the right to highlight menu option.
- The menu option is the last icon on the right.
- Then press enter on the joystick remote to enter settings.

Step: 1

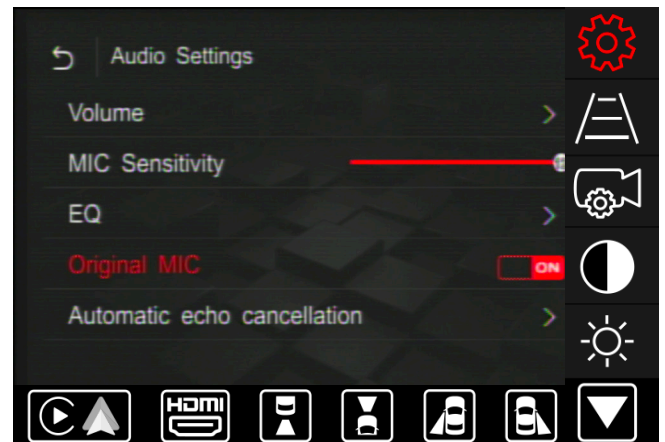

- Rotate joystick remote to highlight the settings gear.
- The settings gear is the top icon.
- Then press enter on the joystick remote to enter settings.

Step: 2

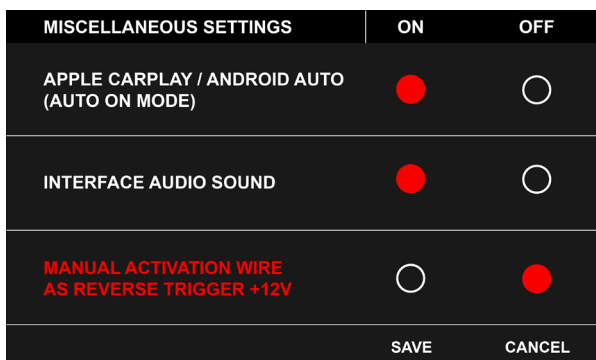

- Rotate joystick to highlight Manual Activation Wire as Reverse Trigger +12V.
- Then press enter button on the joystick remote to change the setting to OFF, once the red dot is set to OFF (image shown on the left), rotate the joystick to highlight SAVE button and press the enter button on the joystick remote to SAVE.

Step: 3

Testing and Settings

STEP 8

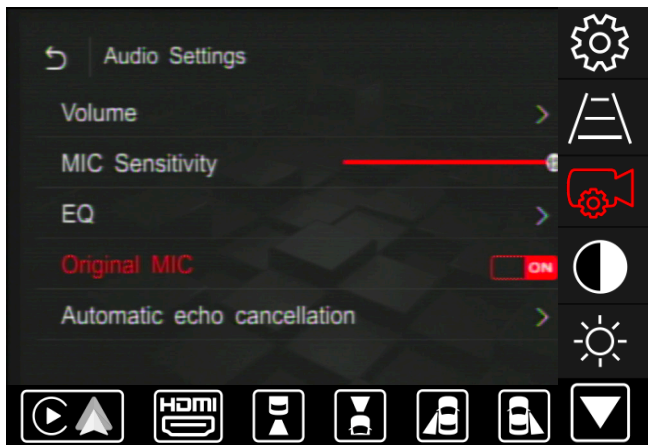

Camera Settings

Rotate joystick to select the Camera Settings option then press enter button on joystick to enter this option.

Step: 1

INPUTS	FACTORY CAMERA	VIDEO INPUT	AFTERMARKET CAMERA	PARKING LINES
	<input checked="" type="radio"/>	<input type="radio"/>	<input type="radio"/>	
	<input type="radio"/>	<input checked="" type="radio"/>	<input type="radio"/>	
	<input type="radio"/>	<input checked="" type="radio"/>	<input type="radio"/>	
	<input type="radio"/>	<input checked="" type="radio"/>	<input type="radio"/>	
SAVE				CANCEL

Camera Settings

- Image above shows you typical camera settings.
- To change camera settings, rotate joystick to highlight the input on the left, once you highlighted desired camera input (rear, front, left, or right), then press enter on the joystick remote to change the option for particular camera input.
- Once the selected option is highlighted, rotate joystick to another camera input.
- Once all camera inputs are set, rotate joystick to highlight SAVE button then press enter on the joystick remote to save options.

Step: 2



Set vehicle in reverse gear to test operation of the factory rear view camera.



Press and hold back button on the supplied joystick remote to exit the interface back into the factory screen.

STEP 9

- Press and hold the back button on the supplied joystick remote to activate NavTool.
- Select Apple CarPlay or Android Auto option depending on your phone.
- Plugin or pair your smartphone wireless to connect Apple CarPlay/Android Auto feature.
- Once your phone is paired or connected via USB cable, Apple CarPlay or Android Auto will appear.

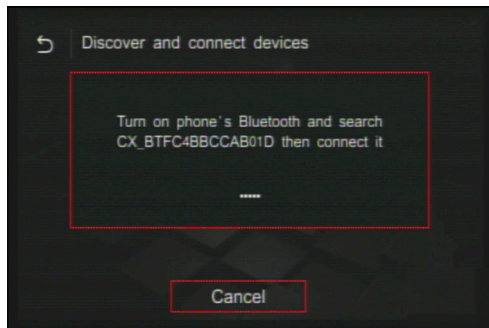
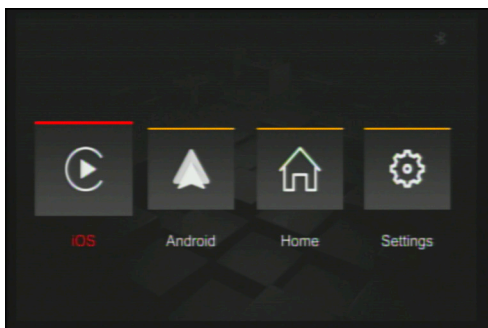

Testing and Settings

STEP 9 Continued

- Once your phone is paired or connected via USB cable, Apple CarPlay or Android Auto will appear.

 If your phone is paired to vehicle bluetooth system for calling, please go into your smartphone bluetooth settings, find your vehicle and do Forget This Device.

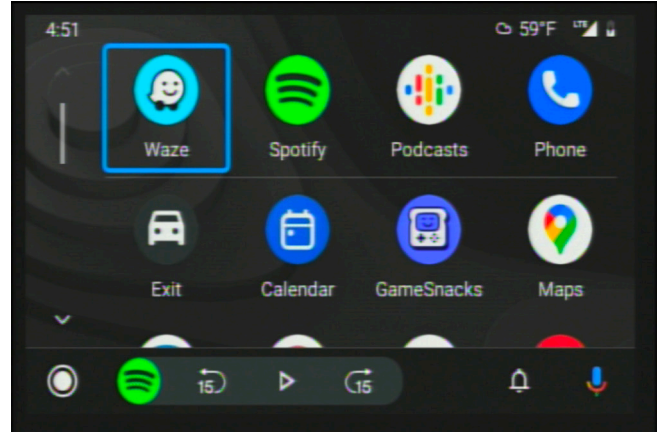
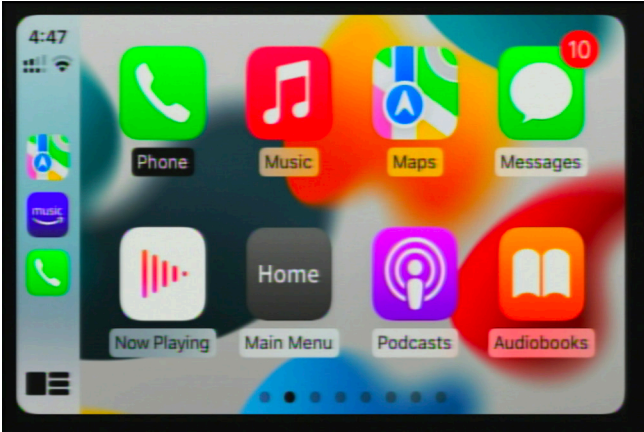

- Do a test call, check that another party hears your voice. If required, adjust microphone sensitivity higher or lower. Typically if you are heard too loud, you may want to lower the sensitivity. If your voice is too low, you may want to increase the sensitivity.

 This test will verify that microphone is working, and audio is heard from the car speakers.

STEP 10

- Test HDMI input if you are connecting any HDMI video source.
- Press menu button on the supplied joystick remote to reveal bottom NavTool menu bar.



- Rotate joystick to the right to select HDMI input, press enter on the joystick to enter HDMI mode.
- Video signal from your HDMI source will appear on the screen. If no video source is connected or the connected source is not correctly working, you will see this message.



- Test AV inputs by selecting them in the menu of the interface or if you are installing any aftermarket cameras.
- To test aftermarket front camera, put the car in reverse then into drive. Front camera should display on the screen.
- To test aftermarket left and right cameras, use left and right turn signals. Left and right cameras should display depending on the turn signal activated.

 After everything is tested and working, reassemble the vehicle.

Vehicle Reassembly Checklist

When performing vehicle reassembly, please make sure to go over the list and checkoff check mark boxes:

- Check to see if all connectors behind the screen, radio, HVAC etc. were reconnected.
- Check that LCD screen shuts off with the key off, and turns back on with the key on.
- Check touchscreen operation.
- Check Heat and AC controls operation.
- Check AM/FM/SAT radio reception.
- Check CD player/changer operation.
- Check GPS signal reception.
- Check cigarette lighter or +12V power source for accessory or constant power.
- Check to see if any other panels that were removed during installation and now being reassembled have all and any electrical connectors reconnected.
- Turn on parking light and check all dashboard lights operation.
- Check all panels for proper fit, make sure no gaps in panels are left behind.

If all steps above are checked off, you will save time, money and have an extremely happy customer.

All above steps eliminate any unnecessary customer comebacks to your shop.

If you require any further assistance please call our tech support line, email or go online

WWW.NAVTOOL.COM

1-877-628-8665

techsupport@navtool.com

Interface Menus and Settings



NavTool Interface Screen

After activating NavTool interface, you will be brought to this screen that you can navigate with the supplied joystick remote.



Apple CarPlay/Android Auto

Press enter button on joystick to enter this option.

After selecting Apple CarPlay/Android Auto you will be brought to your Apple CarPlay/Android Auto screen.

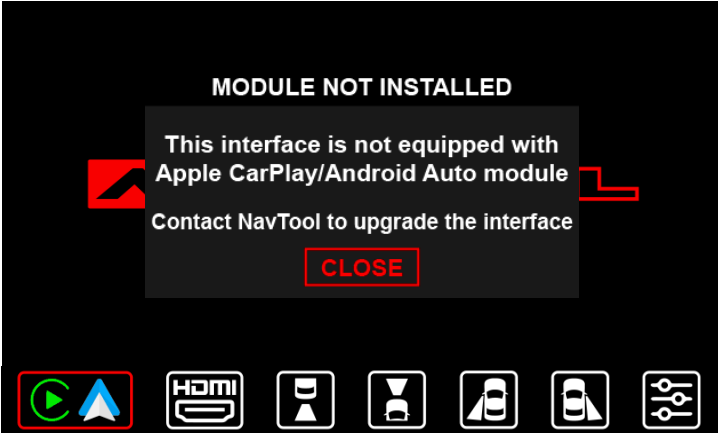

Apple CarPlay/Android Auto Module Not Installed

You will get this message when selecting this option on the NavTool interface that is not equipped with Apple CarPlay/Android Auto module.

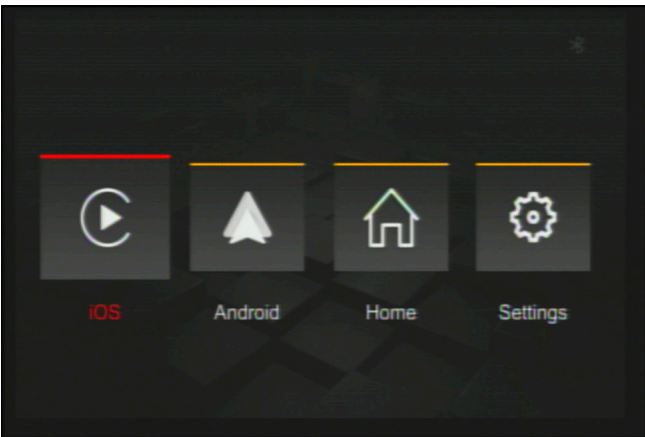

Apple CarPlay

Press enter button on joystick to enter this option.

Selecting this option will take you to your Apple CarPlay screen.

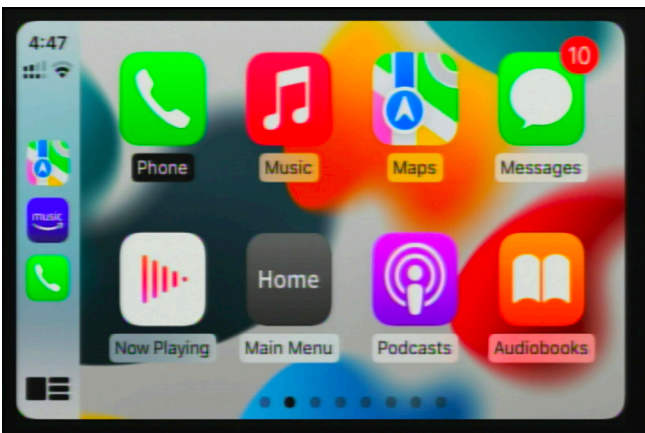

Apple CarPlay Screen

Example of Apple CarPlay screen.

Apple CarPlay is controlled via supplied joystick. Selections are done by rotating joystick left or right, enter button to select. Back button to go back, voice button for Siri.

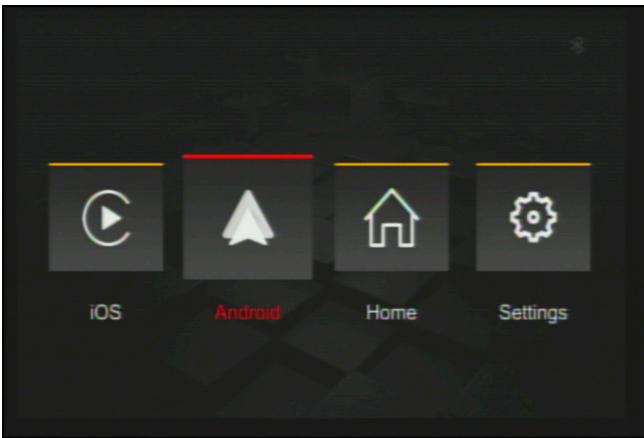

Android Auto

Press enter button on joystick to enter this option.

Selecting this option will take you to your Android Auto screen.

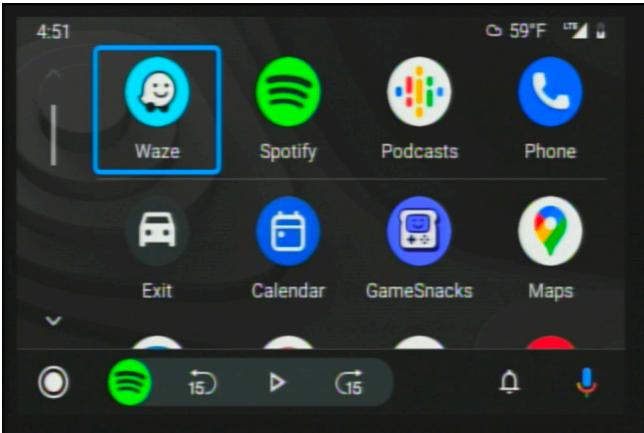

Android Auto Screen

Example of Android Auto screen.

Android Auto is controlled via supplied joystick. Selections are done by rotating joystick left or right, up and down buttons to enter the button menu on Android Auto, enter button to select. Back button to go back, voice button for OK Google.

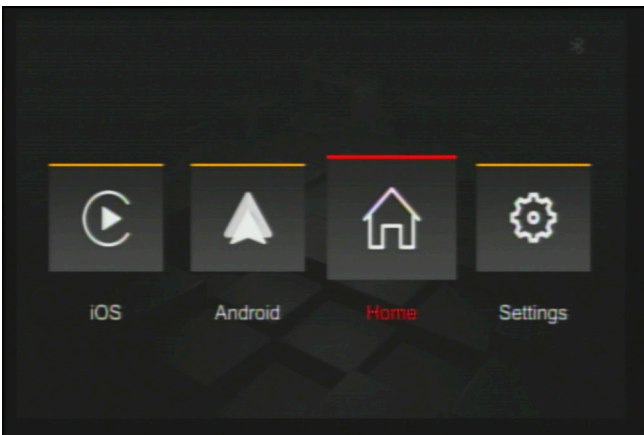

Home

Press enter button on the joystick to exit back to the main menu.

Selecting this option will take you back to the NavTool interface menu.

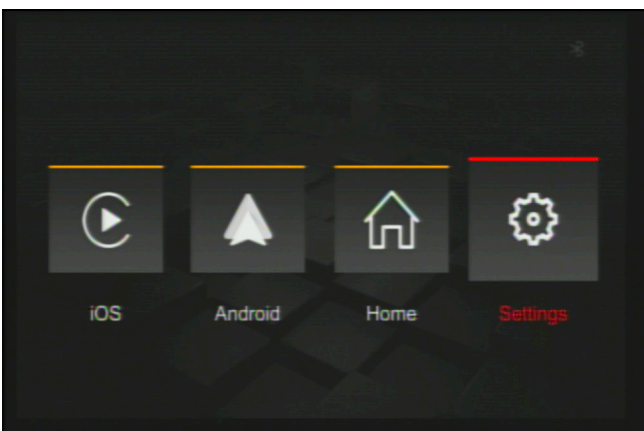

Settings

Press enter button on joystick to enter this option.

Selecting this option will allow you to change your Apple CarPlay and Android Auto settings.

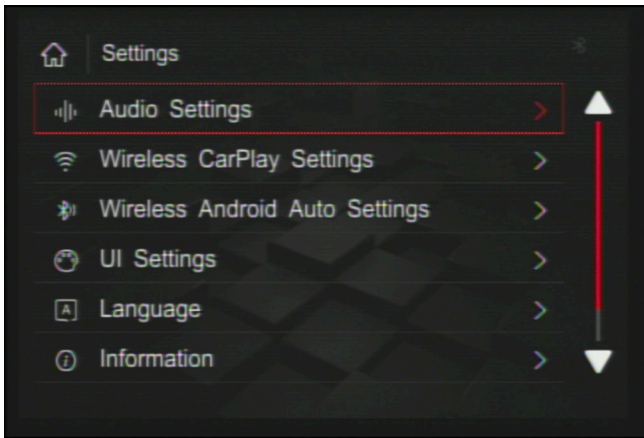

Audio Settings

Press enter button on joystick to enter this option.

Selecting this option will let you change your audio settings.

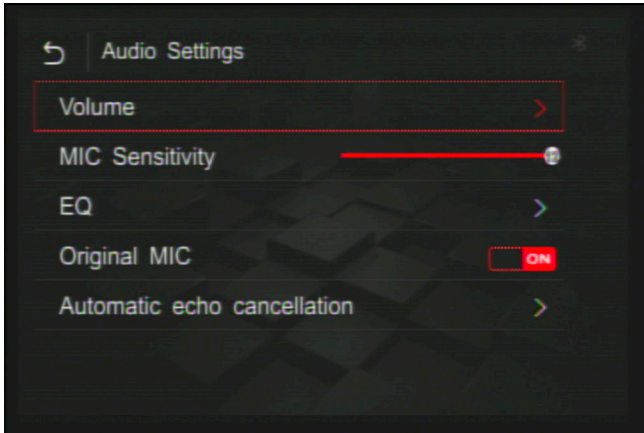

Audio Settings- Volume

Press enter button on joystick to enter this option.

Selecting this option will let you change different volume settings.

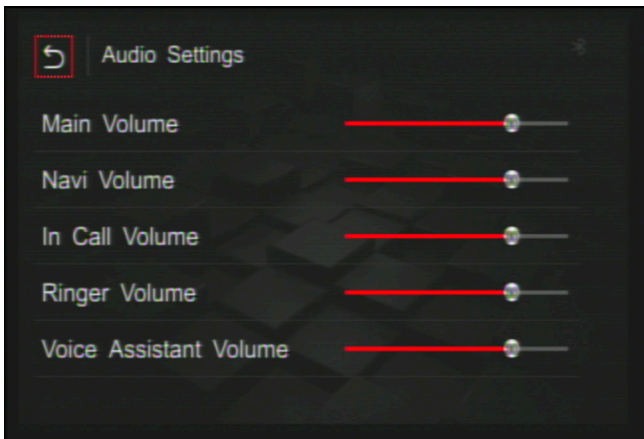

Volume

Select option by rotating joystick to a desired option, then press enter on the joystick to adjust the setting, then press enter on the joystick to save the setting.

You can change your main volume, navigation volume, call volume, ringtone volume, and voice assistant volume.

Rotate your joystick to the back button on the top left corner to go back to your audio settings.

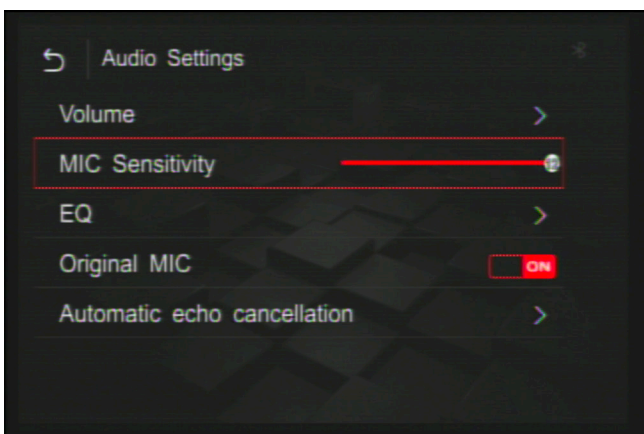

Audio Settings- MIC Sensitivity

Select option by rotating joystick to a desired option, then press enter on the joystick to adjust the setting, then press enter on the joystick to save the setting.

You can change the sensitivity of the microphone to make it more or less sensitive. Make a test call and ask the person how they hear you. If they hear too much noise, you want to make it less sensitive all the way down to 1 or 2. If they don't hear you loud enough, you can increase sensitivity to desired level.

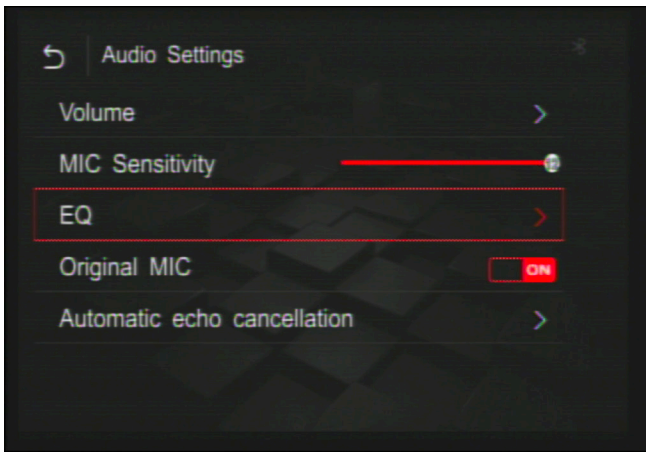

Audio Settings- EQ

Select option by rotating joystick to a desired option, then press enter on the joystick to adjust the setting.

Selecting this option will let you adjust how the audio output sounds.

Press enter button on joystick to enter this option.

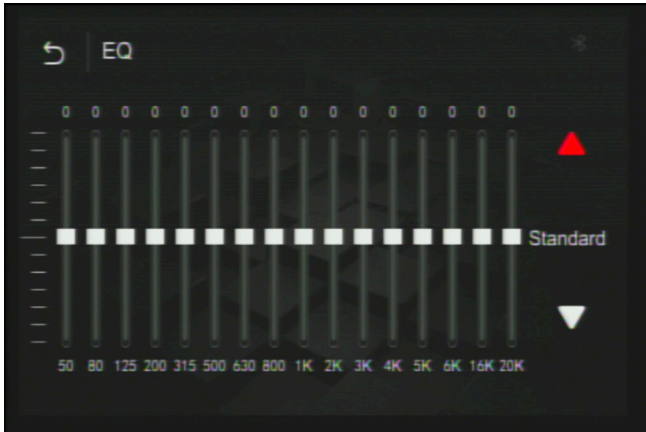

EQ

Select option by rotating joystick to a desired option, then press enter on the joystick to adjust the setting, then press enter on the joystick to save the setting.

You can select different categories for how you want your audio to sound or manually adjust it to your liking.

Rotate your joystick to the back button on the top left corner to go back to your audio settings.

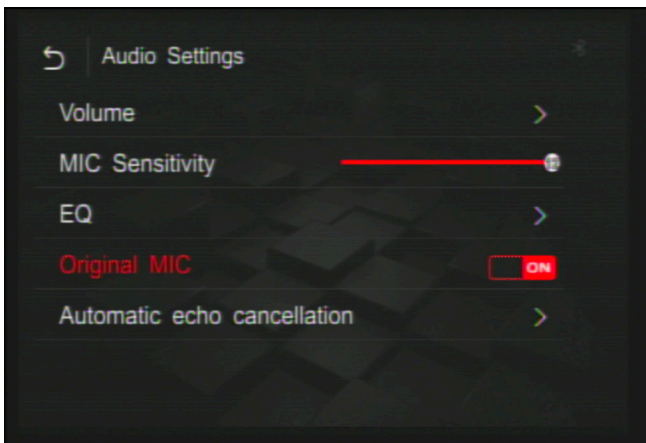

Audio Settings- Original MIC ON

Select option by rotating joystick to a desired option, then press enter on the joystick to adjust the setting, then press enter on the joystick to save the setting.

Only set this setting to ON if your vehicle is equipped with a compatible factory microphone and your interface was not equipped with an external microphone.

Press enter button on joystick to change this option.

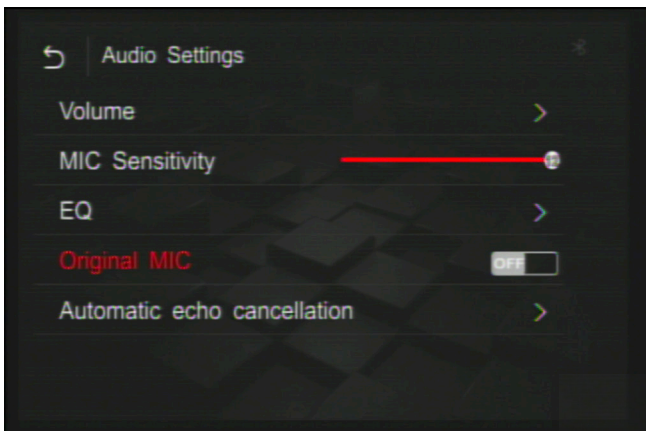

Audio Settings- Original MIC OFF

Select option by rotating joystick to a desired option, then press enter on the joystick to adjust the setting, then press enter on the joystick to save the setting.

This setting must be set to OFF if you received an external microphone with your interface, your vehicle is not equipped with a compatible factory microphone.

Press enter on the joystick to save this option.

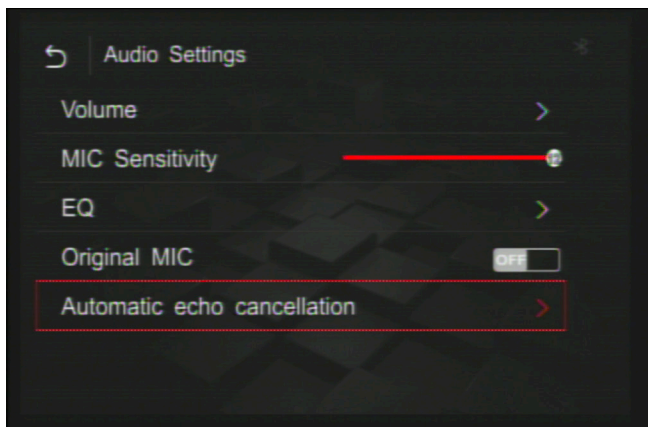

Audio Settings- Automatic Echo Cancellation

Enter this setting to adjust echo cancellation

Rotate your joystick to the back button on the top left corner to go back to your interface settings.

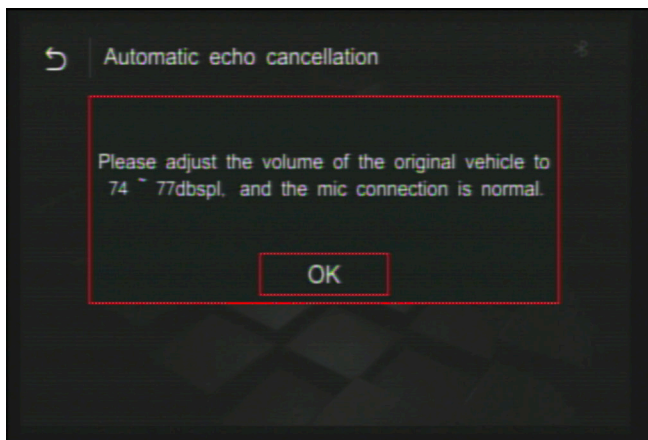

Automatic Echo Cancellation

Follow the prompt on the screen if you need to know how to set the vehicle to 74 ~ 77 db, you can find an app on the app store that measures db levels.

Rotate your joystick to the back button on the top left corner to go back to your audio settings.

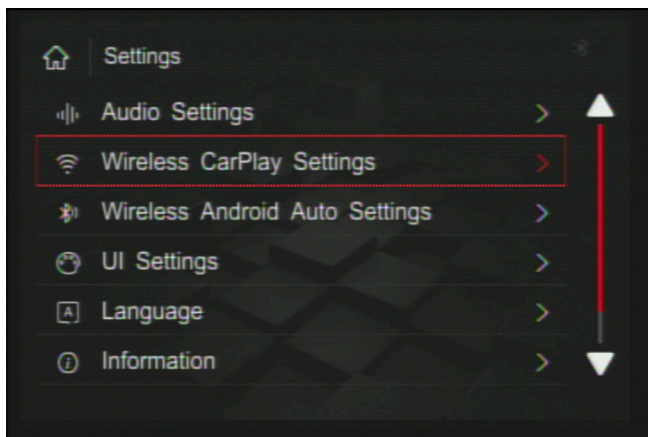

Wireless CarPlay Settings

Rotate joystick to select wireless CarPlay Settings then press enter on the joystick to enter the option.

Selecting this option will let you change your Apple CarPlay settings.



Wireless CarPlay Connection

Select option by rotating joystick to a desired option, then press enter on the joystick to adjust the setting.

You can select this option to change wireless CarPlay option ON or OFF.



Wireless CarPlay Settings- 2.4G/5G

Select option by rotating joystick to a desired option, then press enter on the joystick to adjust the setting.

You can change between 2.4G and 5G wireless connection, default option is 5G.

There is no need to enter this option and change anything, the default setting will work on all phones.



Wireless CarPlay Settings- Online Device List

Select option by rotating joystick to a desired option, then press enter on the joystick to adjust the setting.

In this option, you can see currently paired devices.

There is no need to enter this option unless you need to delete a phone in the future.



Wireless CarPlay Settings- Discover and Connect Devices

Select option by rotating joystick to a desired option, then press enter on the joystick to adjust the setting.

This option lets you connect your iPhone wirelessly for wireless Apple CarPlay option.

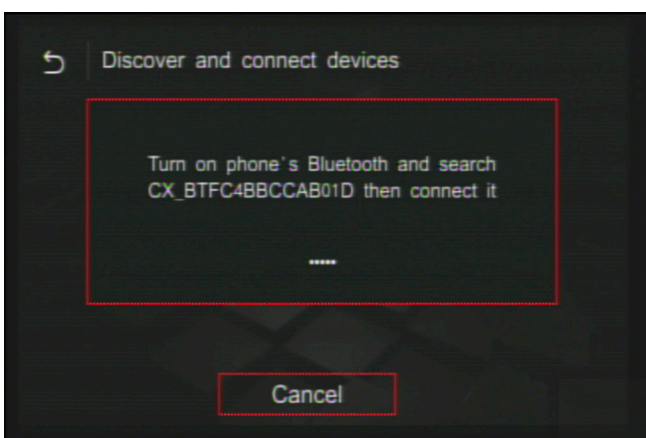

Discover and Connect Devices

After selecting Discover and Connect Devices, you will have a Bluetooth connection available for your phone to connect to and pair to the interface.

Rotate your joystick to the back button on the top left corner to go back to your Apple CarPlay settings.



Wireless CarPlay Settings- Paired Device List

Select option by rotating joystick to a desired option, then press enter on the joystick to adjust the setting.

In this option, you can see all paired devices.

There is no need to enter this option unless you need to delete a phone in the future.

Rotate your joystick to the back button on the top left corner to go back to your interface settings.

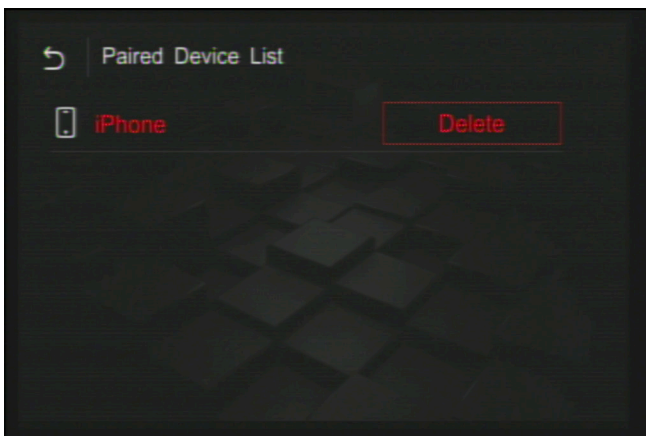

Paired Device List

Select option by rotating joystick to a desired option, then press enter on the joystick to adjust the setting.

Select delete for the device you wish to delete from the paired device list.

There is no need to enter this option unless you need to delete a phone in the future.

Rotate your joystick to the back button on the top left corner to go back to your Apple CarPlay settings.

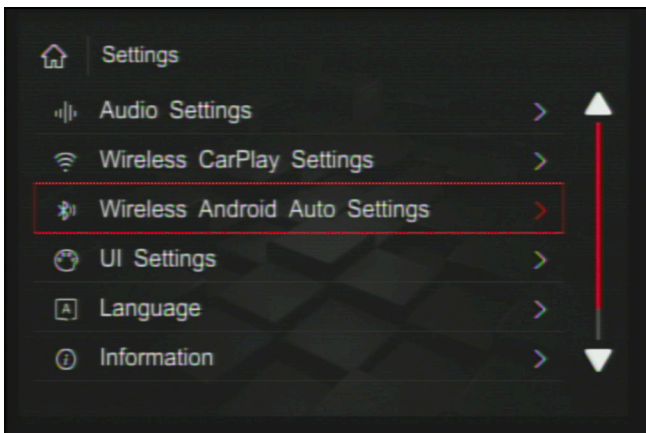

Wireless Android Auto Settings

Select option by rotating joystick to a desired option, then press enter on the joystick to adjust the setting.

Selecting this option will let you change your Android Auto settings.

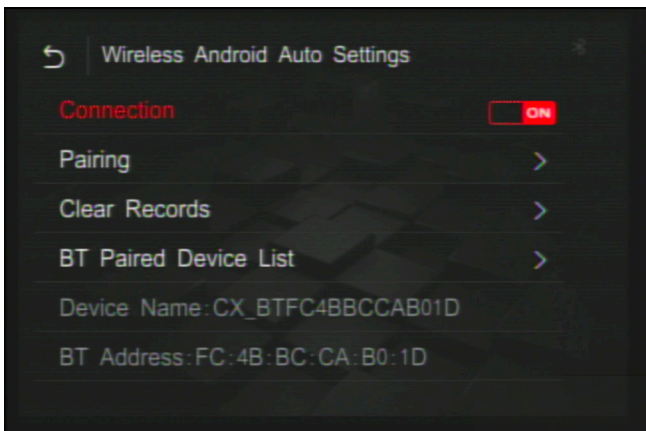

Wireless Android Auto Settings- Connection

Select option by rotating joystick to a desired option, then press enter on the joystick to adjust the setting.

You can select this option to change wireless Android Auto option ON or OFF.



Wireless Android Auto Settings- Pairing

Select option by rotating joystick to a desired option, then press enter on the joystick to adjust the setting.

This option lets you connect your android wirelessly for wireless Android Auto option.

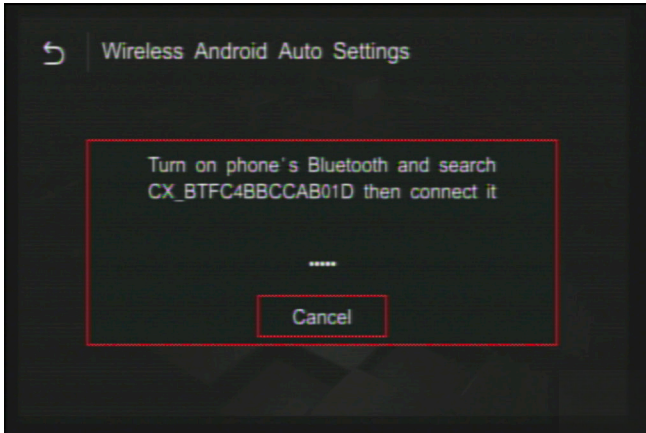

Pairing

After selecting Pairing, you will have a Bluetooth connection available for your phone to connect to and pair to the interface.

Rotate your joystick to the back button on the top left corner to go back to your Android Auto settings.

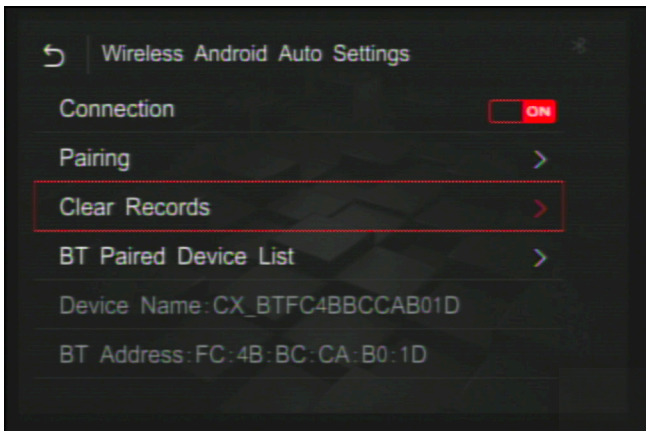

Wireless Android Auto Settings- Clear Records

Select option by rotating joystick to a desired option, then press enter on the joystick to adjust the setting.

In this option, you can see all paired devices.

There is no need to enter this option unless you need to delete a phone in the future.

Rotate your joystick to the back button on the top left corner to go back to your interface settings.

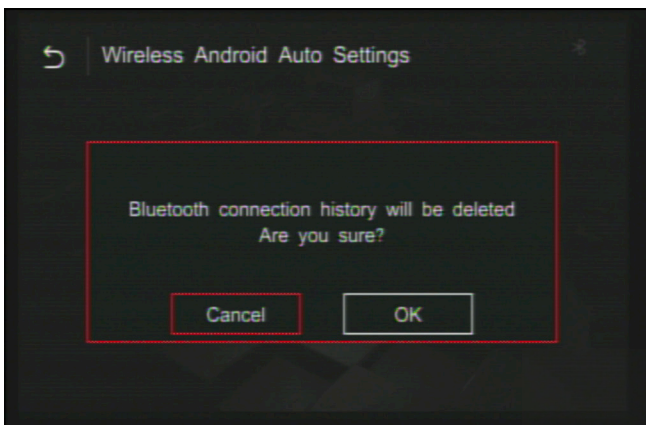

Clear Records

Select option by rotating joystick to a desired option, then press enter on the joystick to adjust the setting.

Select delete for the device you wish to delete from the paired device list.

There is no need to enter this option unless you need to delete a phone in the future.

Rotate your joystick to the back button on the top left corner to go back to your Android Auto settings.

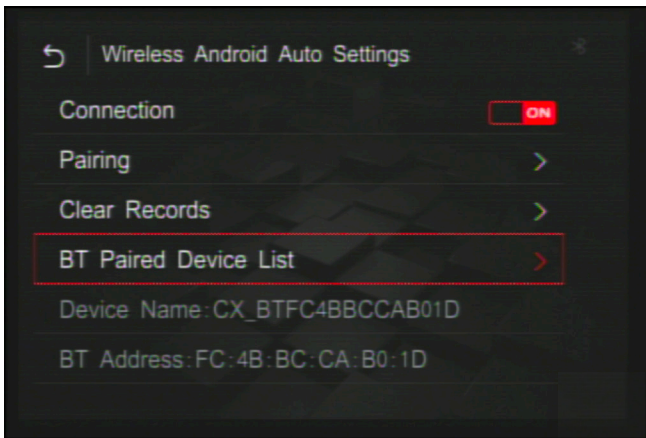

Wireless Android Auto Settings- BT Paired Device List

Select option by rotating joystick to a desired option, then press enter on the joystick to adjust the setting.

In this option, you can see currently paired devices.

There is no need to enter this option unless you need to delete a phone in the future.

Rotate your joystick to the back button on the top left corner to go back to your interface settings.

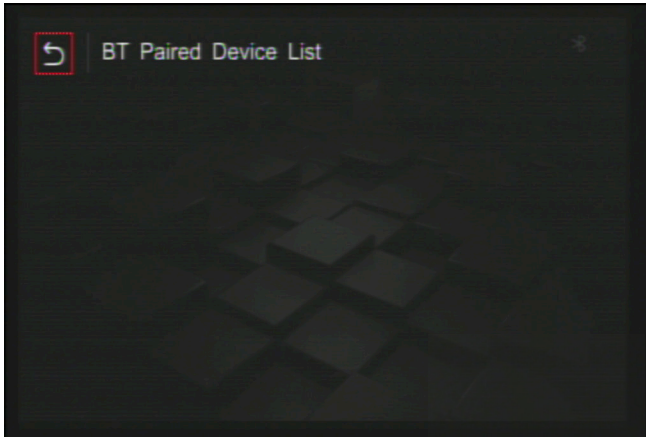

Bluetooth Paired Device List

Select option by rotating joystick to a desired option, then press enter on the joystick to adjust the setting.

Select delete for the device you wish to delete from the paired device list.

There is no need to enter this option unless you need to delete a phone in the future.

Rotate your joystick to the back button on the top left corner to go back to your Android Auto settings.

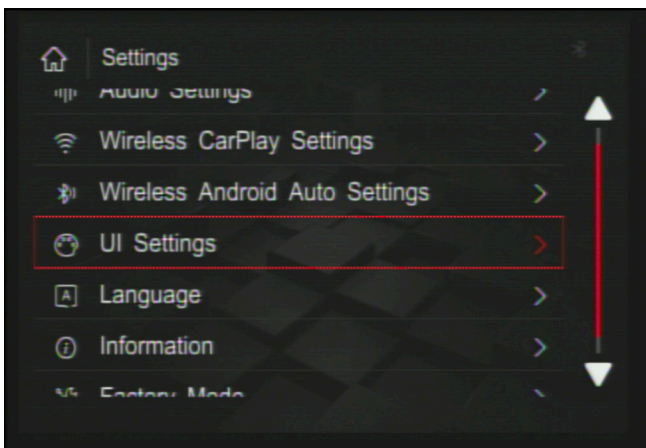

UI Settings

Select option by rotating joystick to a desired option, then press enter on the joystick to adjust the setting.

Selecting this will allow you to change your UI settings of the interface.

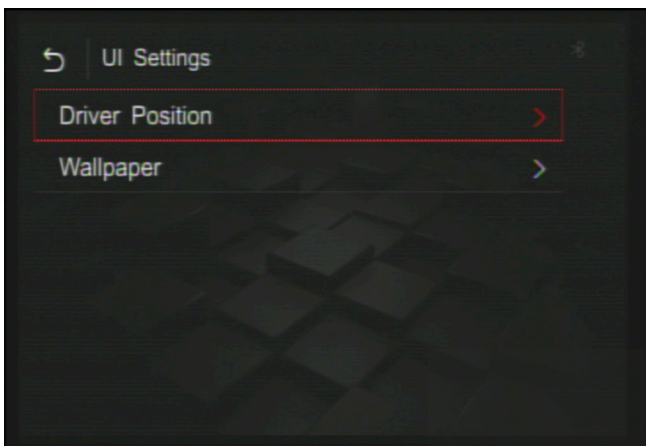

UI Settings- Driver Position

Select option by rotating joystick to a desired option, then press enter on the joystick to adjust the setting.

You can select or change which driver position you are in.

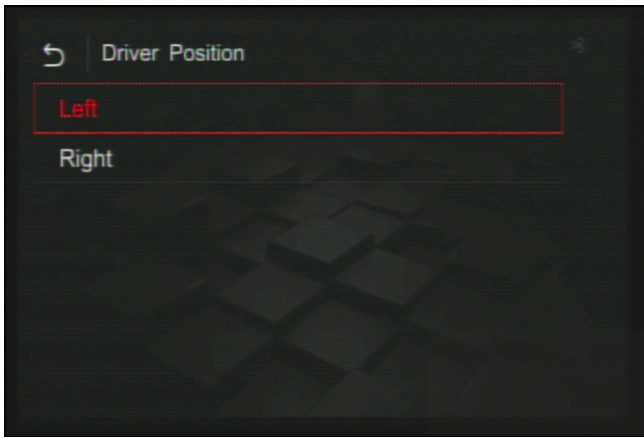

Driver Position

Select option by rotating joystick to a desired option, then press enter on the joystick to adjust the setting.

You can select which side the driver position is on your car, either left or right. Also you can move the menu position of Apple CarPlay/ Android Auto on left or right in case something is blocking the menu.

Rotate your joystick to the back button on the top left corner to go back to your UI settings.

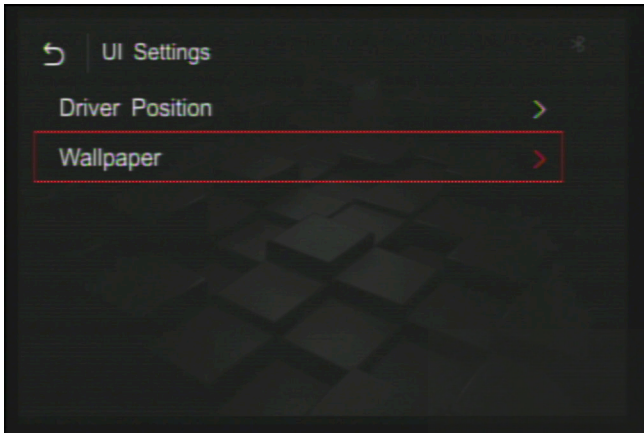

UI Settings- Wallpaper

Select option by rotating joystick to a desired option, then press enter on the joystick to adjust the setting.

After selecting this, you can change what wallpaper you want to have displayed on the interface.

Rotate your joystick to the back button on the top left corner to go back to your interface settings.

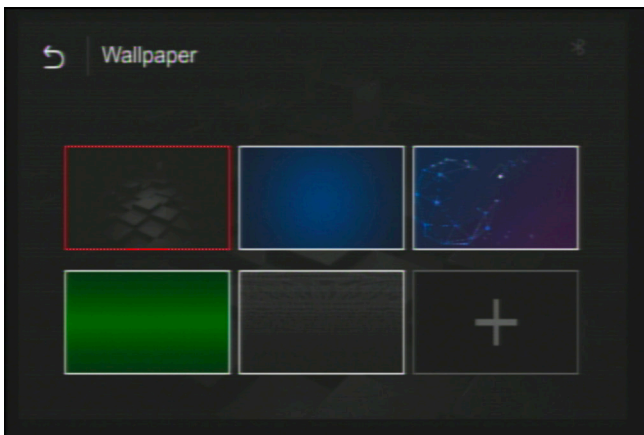

Wallpaper

Select option by rotating joystick to a desired option, then press enter on the joystick to adjust the setting.

You can select which wallpaper you want to have displayed on the interface.

Rotate your joystick to the back button on the top left corner to go back to your UI settings.

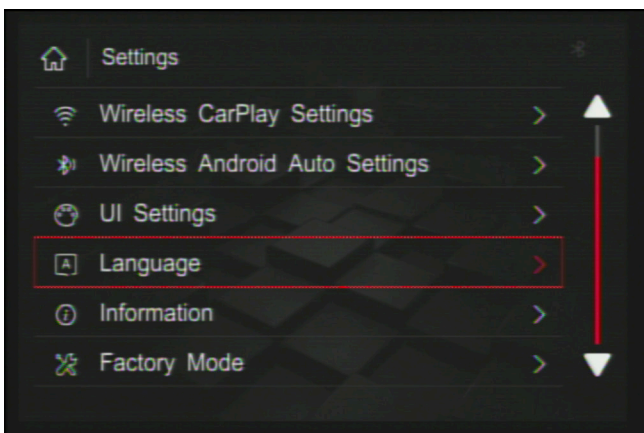

Language

Select option by rotating joystick to a desired option, then press enter on the joystick to adjust the setting.

You can select this to change the language of the interface.

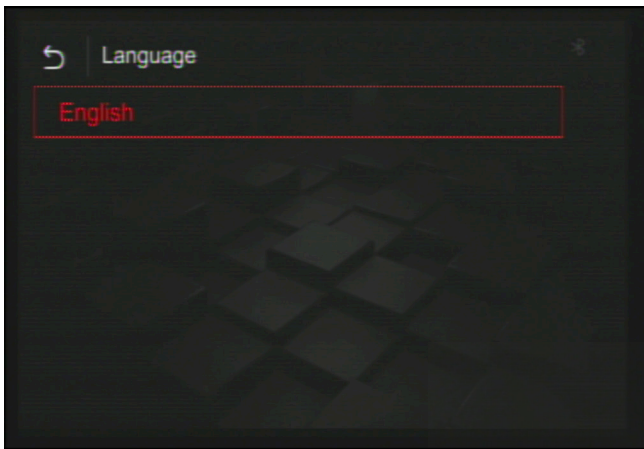

Language

Select option by rotating joystick to a desired option, then press enter on the joystick to adjust the setting.

Selection screen for the language setting.

Rotate your joystick to the back button on the top left corner to go back to your language settings.

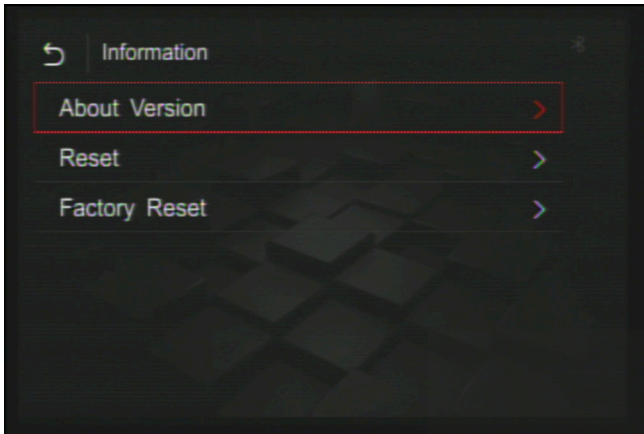

Information

Select option by rotating joystick to a desired option, then press enter on the joystick to adjust the setting.

After selecting information, you can find more information about the interface version, and the ability to reset or factory reset.

Rotate your joystick to the back button on the top left corner to go back to your interface settings.

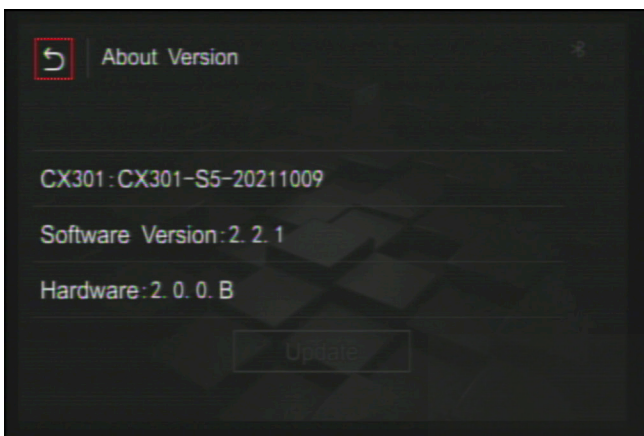

About Version

Select option by rotating joystick to a desired option, then press enter on the joystick to adjust the setting.

After selecting information, you can find more information about the interface version, and the ability to reset or factory reset.

Rotate your joystick to the back button on the top left corner to go back to your information settings.



Reset

Select option by rotating joystick to a desired option, then press enter on the joystick to adjust the setting.

Selecting this will let you reset your interface options.

Rotate your joystick to the back button on the top left corner to go back to your information settings.

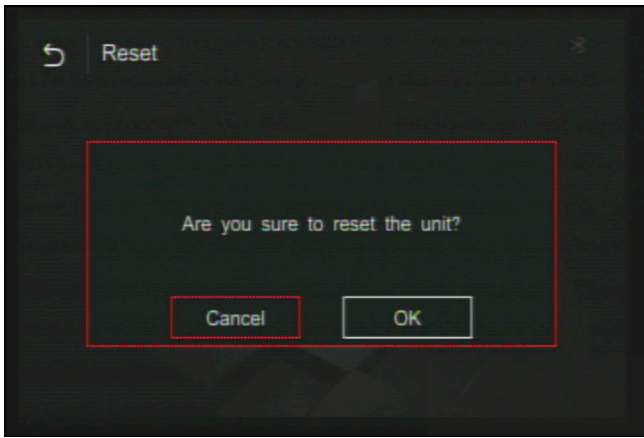

Reset

Select option by rotating joystick to a desired option, then press enter on the joystick to adjust the setting.

Selecting this will reset the interface unit and the options you have changed.

Rotate your joystick to the back button on the top left corner to go back to your information settings.

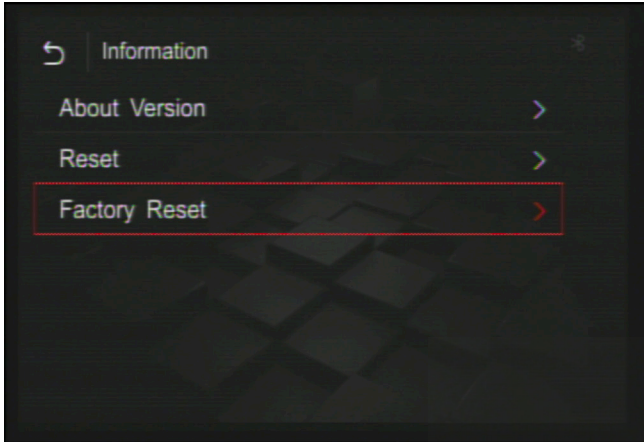

Information- Factory Reset

Select option by rotating joystick to a desired option, then press enter on the joystick to adjust the setting.

Selecting this will allow you to factory reset your interface.

Rotate your joystick to the back button on the top left corner to go back to your interface settings.

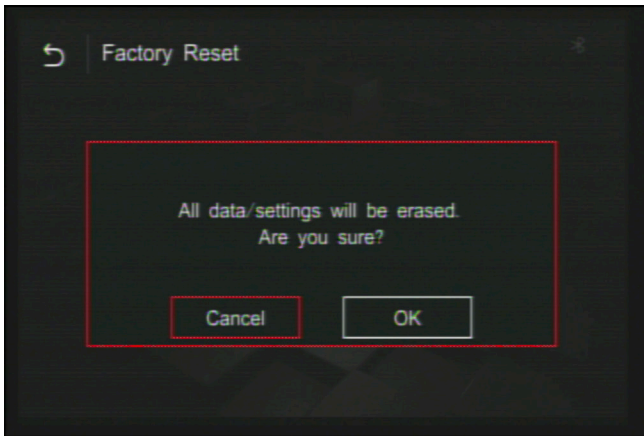

Factory Reset

Select option by rotating joystick to a desired option, then press enter on the joystick to adjust the setting.

Factory resetting your interface will erase all data and settings that were previously on it.

Rotate your joystick to the back button on the top left corner to go back to your information settings.

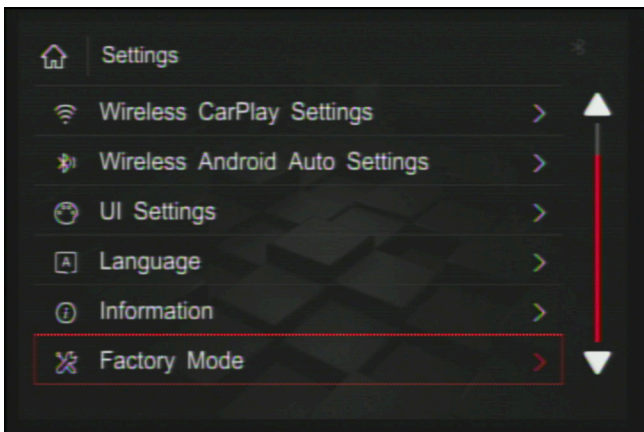

Factory Mode

Do not enter this mode as it is password protected and changing any features will break the interface.

Press and hold the back button until you see the button menu.



HDMI

Rotate joystick to select HDMI option then press enter button on joystick to enter this option.

After selecting HDMI with a HDMI source attached, you will be brought to your HDMI's device screen and connected image will appear on the screen.

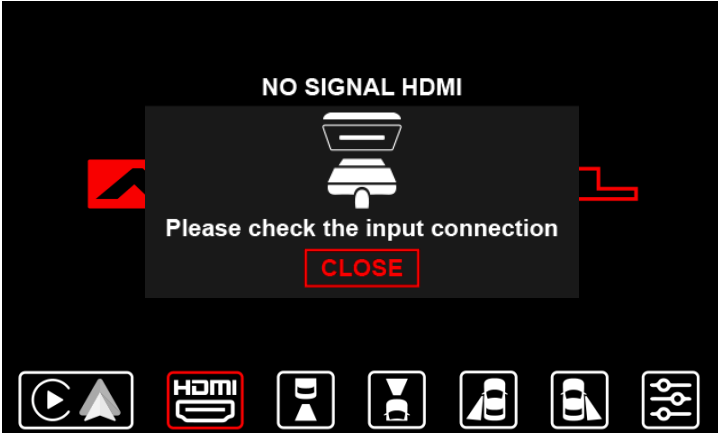

No HDMI Signal

You will get this message when selecting this input with no HDMI source connected to interface.

This part of the page has been intentionally left blank



Back-Up Camera

Rotate joystick to select Back-Up Camera option then press enter button on joystick to enter this option.

After selecting the back-up camera input, you will be brought to your back up camera screen. This will not work if a back-up camera is not installed. (Note: This input will not display factory installed rear-view camera)



Front Camera

Rotate joystick to select Front Camera option then press enter button on joystick to enter this option.

After selecting the front camera input, you will be brought to your front camera screen. This will not work if a front camera is not installed. (Note: This input will not display factory installed forward facing camera)



Left Lane Watch Camera

Rotate joystick to select Left Lane Watch Camera option then press enter button on joystick to enter this option.

After selecting the left lane watch camera input, you will be brought to your left lane watch camera screen. This will not work if a left lane watch camera is not installed. (Note: This input will not display factory installed left lane watch camera)



Right Lane Watch Camera

Rotate joystick to select Right Lane Watch Camera option then press enter button on joystick to enter this option.

After selecting the right lane watch camera input, you will be brought to your right lane watch camera screen. This will not work if a right lane watch camera is not installed. (Note: This input will not display factory installed right lane watch camera)



Settings

Rotate joystick to select the settings option then press enter button on joystick to enter this option.

After selecting the settings option, a menu will expand showing different interface settings you can change.



Settings Options Menu

Rotate joystick to select the settings option then press enter button on joystick to enter this option.

Selecting the setting options input, you will have access to change brightness, contrast, camera settings, parking line settings, and interface settings. You can close this by selecting the down arrow.



Brightness

Rotate joystick to select the brightness option then press enter button on joystick to enter this option.

After selecting brightness, you can adjust the brightness of the interface. The white bar in the middle shows what the interface brightness is at. You can lower the brightness of the interface by selecting the icon on the left and you can increase the brightness of the interface by selecting the icon on the right. Save or cancel any changes you have made.

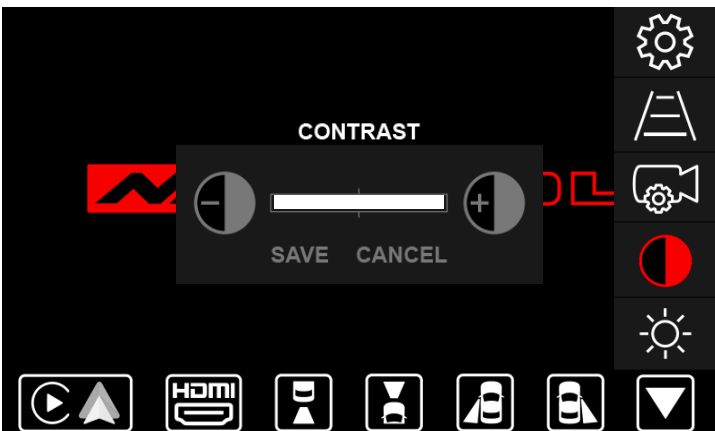

Contrast

Rotate joystick to select the contrast option then press enter button on joystick to enter this option.

After selecting contrast, you can adjust the interface's contrast. The white bar in the middle shows what the interface contrast is at. You can lower the contrast of the interface by selecting the icon on the left and you can increase the contrast of the interface by selecting the icon on the right. Save or cancel any changes you have made.



Camera Settings

Rotate joystick to select the Camera Settings option then press enter button on joystick to enter this option.

How to navigate the interface to change your camera settings.

Camera Settings Menu

Rotate joystick to select the Camera Settings option then press enter button on joystick to enter this option.

Rotate the joystick to select a particular camera input. Then press enter on the joystick to select an option you want for that particular camera input.

Factory camera: Select this option if your vehicle is equipped with a factory installed rear view camera.

Video input: Select this option if your vehicle is not equipped with a factory rear view camera and you are not planning to add a aftermarket camera or if you wish to use this input as a video input.

Aftermarket camera: Select this option if you are installing an aftermarket rear view camera.

Parking lines: Select this option if you are installing an aftermarket rear view camera and you wish to add distance lines to the camera image.

Factory camera: Select this option if your vehicle is equipped with a factory installed forward facing camera. Do not select this option if your vehicle is equipped with 360 degree parking cameras, 360 degree front parking camera is not considered forward facing camera.

Video input: Select this option if your vehicle is not equipped with a factory forward facing camera and you are not planning to add a aftermarket camera or if you wish to use this input as a video input.

Aftermarket camera: Select this option if you are installing an aftermarket forward facing camera.

Parking lines: Select this option if you are installing an aftermarket forward facing camera and you wish to add distance lines to the camera image.

INPUTS	FACTORY CAMERA	VIDEO INPUT	AFTERMARKET CAMERA	PARKING LINES
	<input type="radio"/>	<input type="radio"/>	<input type="radio"/>	<input type="radio"/>
	<input type="radio"/>	<input type="radio"/>	<input type="radio"/>	<input type="radio"/>
	<input type="radio"/>	<input type="radio"/>	<input type="radio"/>	<input type="radio"/>
	<input type="radio"/>	<input type="radio"/>	<input type="radio"/>	<input type="radio"/>
SAVE				CANCEL

Factory camera: Select this option if your vehicle is equipped with a factory installed right lane watch camera. Do not select this option if your vehicle is equipped with 360 degree parking cameras, 360 degree right parking camera is not considered forward facing camera.

Video input: Select this option if your vehicle is not equipped with a factory right lane watch camera and you are not planning to add a aftermarket camera or if you wish to use this input as a video input.

Aftermarket camera: Select this option if you are installing an aftermarket right lane watch camera.

Parking lines: Select this option if you are installing an aftermarket right lane watch camera and you wish to add distance lines to the camera image.

Factory camera: Select this option if your vehicle is equipped with a factory installed left lane watch camera. Do not select this option if your vehicle is equipped with 360 degree parking cameras, 360 degree front parking camera is not considered forward facing camera.

Video input: Select this option if your vehicle is not equipped with a factory left lane watch camera and you are not planning to add a aftermarket camera or if you wish to use this input as a video input.

Aftermarket camera: Select this option if you are installing an aftermarket left lane watch camera.

Parking lines: Select this option if you are installing an aftermarket left lane watch camera and you wish to add distance lines to the camera image.





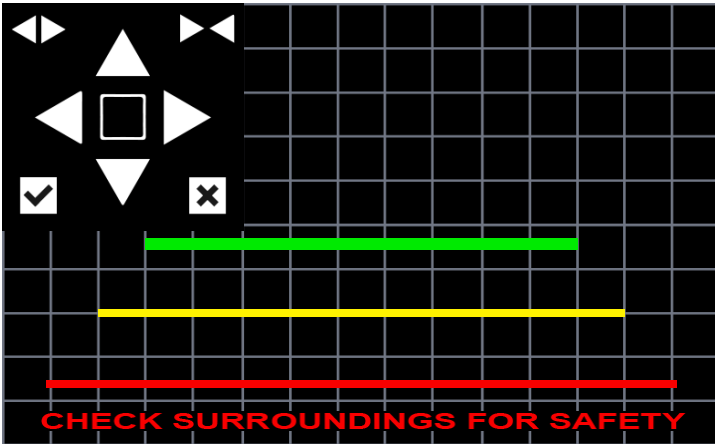

Parking Line Settings

How to navigate the interface to change parking line settings. You can only access this setting when you are on the particular camera input. Select the camera input prior to going into parking line settings.



Parking Line Settings

After selecting parking line settings, you can adjust the parking lines of the interface. Your interface will display which camera input you chose with gridlines instead of a black background. You can choose which parking line you want to make changes to by selecting the square in the middle. The white circle in the square indicates which parking line you are making changes to.

-  Green Parking Line
-  Yellow Parking Line
-  Red Parking Line
-  Green Parking Line Selected
-  Yellow Parking Line Selected
-  Red Parking Line Selected

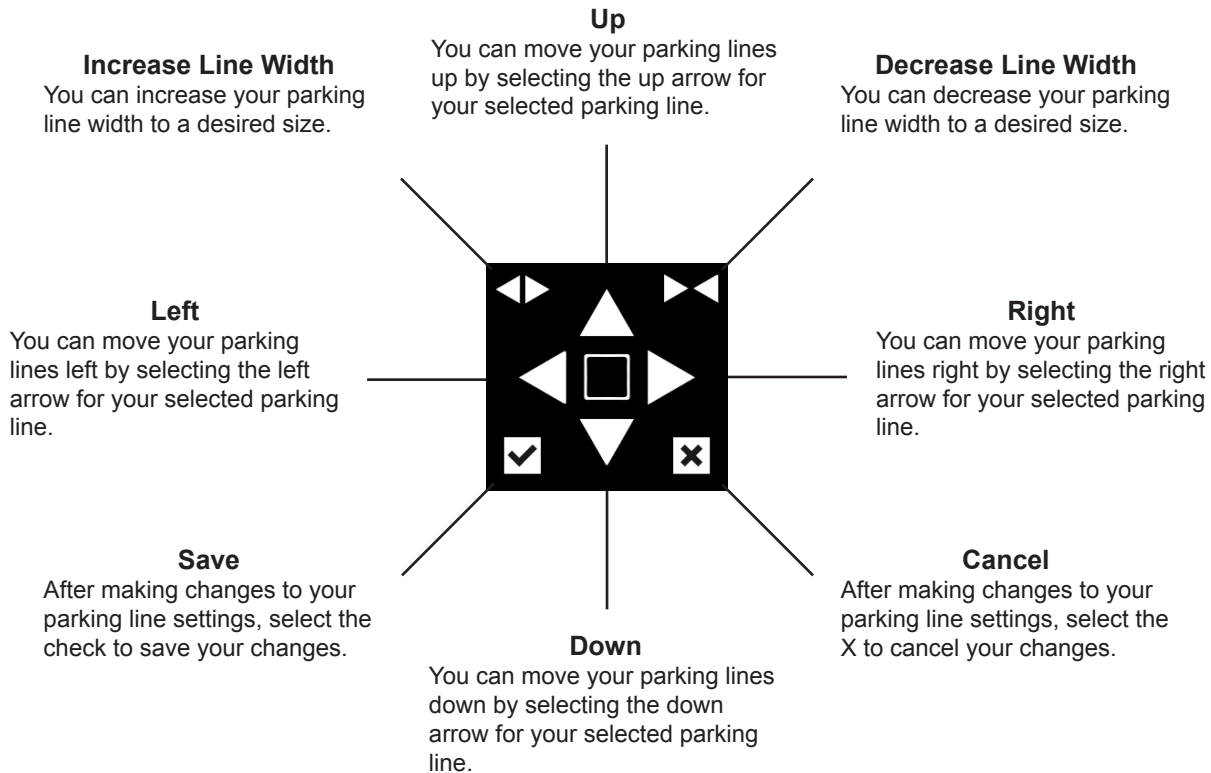



Interface Settings

Rotate joystick to select the Interface Settings option then press enter button on joystick to enter this option.

How to navigate the interface to change your interface settings. After selecting interface settings, you can adjust miscellaneous settings of the interface. Save or cancel any interface changes.

Set this feature to ON if you want to enter Apple CarPlay/Android Auto mode when activating the interface, and bypassing the NavTool menu.

Set this feature to OFF if you want to enter NavTool menu upon activation of the interface.

MISCELLANEOUS SETTINGS	ON	OFF
APPLE CARPLAY / ANDROID AUTO (AUTO ON MODE)	<input type="radio"/>	<input type="radio"/>
INTERFACE CHIRP SOUND	<input type="radio"/>	<input type="radio"/>
MANUAL ACTIVATION WIRE AS REVERSE TRIGGER +12V	<input type="radio"/>	<input type="radio"/>
	SAVE	CANCEL

Turn this feature to ON to enable audio feedback from the interface when activating the interface or when smartphone wireless connection is established.

Turn this feature to OFF if audio feedback from the interface is not required.

Turn ON manual activation wire as reverse trigger if your manual tells you to or if done by an installer. Do not change if they have set this to on.

Turn OFF: Most vehicles will have manual activation wire turned off. Do not change unless your manual tells you or if done by an installer.

How to Connect Rear Screens to Car With AV Input



Car Monitor



NavTool Interface



HDMI to AV Adaptor



1 in 2 Out HDMI Splitter



HDMI Sources

How to Connect Rear Screens to Car With HDMI Input



Car Monitor



NavTool Interface



Car HDMI Input



1 in 2 Out HDMI Splitter



HDMI Sources

User Manual For Consumer

Thank you for purchasing NavTool. If you have any questions, please call toll-free at 877-628-8665.

The color/navigation screen will display a factory image when you first start your vehicle.

- Set the radio to AUX input to hear the Apple CarPlay/Android Auto audio. Navigation directions, music, and phone calls from the NavTool Apple CarPlay/Android Auto interface will play via AUX input of the radio. See page C3 for details.
- How to activate: To activate/turn ON the interface, press and hold the back button on the supplied joystick. See page C4 for the joystick controller operation buttons.
- Press the menu button on the joystick remote control to bring up the bottom menu of the interface. Rotate the joystick left or right to select the desired menu, then press the enter button to select the menu option. See page C4 for the joystick controller operation buttons.

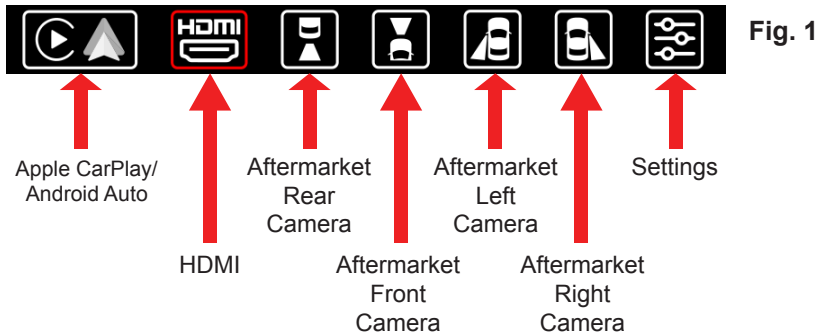

How to exit video inputs: To leave HDMI or any camera inputs, press the menu button on the supplied remote control. See page C3 for details.

Aftermarket Camera Operation: The factory rearview camera will continue to work in reverse. If you installed a forward-facing camera, you could manually select it in the menu, or it will automatically display up to 10 miles per hour on the screen. This automation will happen when you put the car into drive after reverse gear. Aftermarket left and right lane watch cameras will work with respective turn signals while driving or can be selected manually via the menu.

How to deactivate: To deactivate/turn OFF the interface, press and hold the back button. The bottom menu will appear, then release the back button and press the back button again until the interface is OFF. You will now see the factory display menu.

CarPlay/Android Auto enter and exit (To change automatic or standard mode, see page C2)

Automatic Mode: Suppose automatic Apple CarPlay/Android Auto mode is activated. When you press and hold the back button on the supplied remote, you will automatically enter Apple CarPlay/Android Auto mode bypassing the NavTool menu. You can automatically get out of the Apple CarPlay mode by going to the Main Menu App inside the Apple CarPlay. Or you can get out of Android Auto mode by going to the Exit App inside Android Auto.

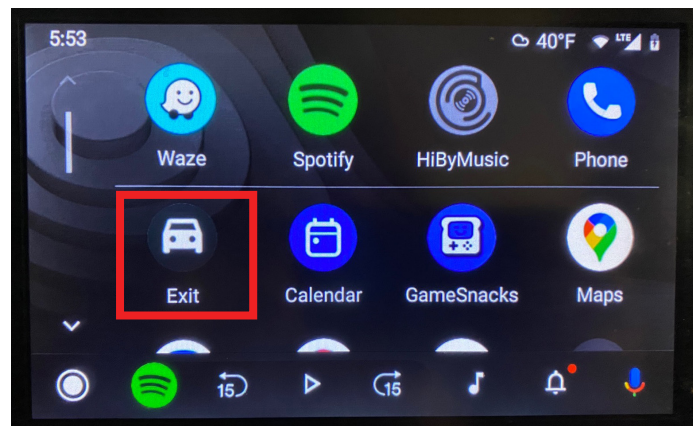
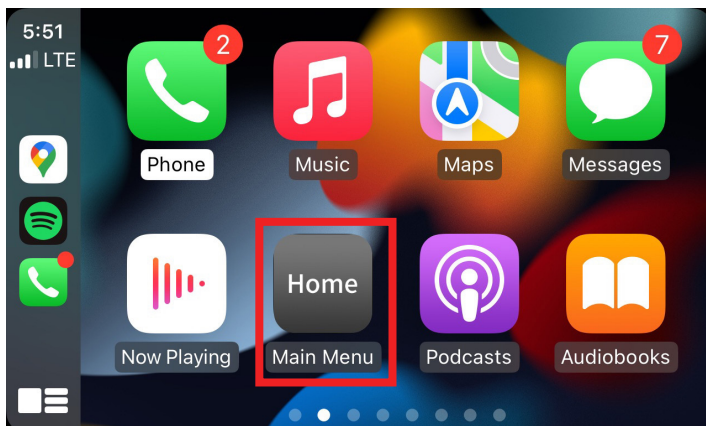

Standard Mode: Suppose automatic Apple CarPlay/Android Auto mode is not activated. You can get out of the Apple CarPlay mode by going to the Main Menu App inside the Apple CarPlay. Or you can get out of Android Auto mode by going to the Exit App inside Android Auto. This action will bring you to the NavTool interface main menu.

See Fig. 1 above.



- Press the menu button on the remote control to reveal NavTool menu bar.
- Rotate the joystick to the right to highlight menu option.
- The menu option is the last icon on the right.
- Then press enter on the joystick remote to enter settings.



Interface Settings

- Rotate the joystick remote to highlight the settings gear.
- The settings gear is the top icon.
- Then press enter on the joystick remote to enter settings.

Set this feature to ON if you want to enter Apple CarPlay/Android Auto mode when activating the interface, and bypassing the NavTool menu.

Set this feature to OFF if you want to enter NavTool menu upon activation of the interface.

MISCELLANEOUS SETTINGS	ON	OFF
APPLE CARPLAY / ANDROID AUTO (AUTO ON MODE)	<input type="radio"/>	<input type="radio"/>
INTERFACE CHIRP SOUND	<input type="radio"/>	<input type="radio"/>
MANUAL ACTIVATION WIRE AS REVERSE TRIGGER +12V	<input type="radio"/>	<input type="radio"/>
	SAVE	CANCEL

Turn this feature to ON to enable audio feedback from the interface when activating the interface or when smartphone wireless connection is established.

Turn this feature to OFF if audio feedback from the interface is not required.

Turn ON manual activation wire as reverse trigger if your manual tells you to or if done by an installer. Do not change if they have set this to on.

Turn OFF: Most vehicles will have manual activation wire turned off. Do not change unless your manual tells you or if done by an installer.

- Rotate joystick to highlight desired option.
- Then press enter button on the joystick remote to change the setting ON or OFF. Once the red dot is set to a desired condition, rotate the joystick to highlight SAVE button and press the enter button on the joystick remote to save.

Setting Radio to Auxiliary



Set Radio to AUX Audio Input:

- **SRCE Button:** Press the SRCE button to display the audio screen. Press to switch between AM, FM, or XM, if equipped, Disc, or AUX (Auxiliary). Must set a radio to auxiliary/AUX before activating NavTool to hear audio from car speakers. See page 11 step 6 for AUX connection.
- Audio will not play through car speakers if AUX input is not connected or radio is not set to AUX input.

Remote Control Operation Guide

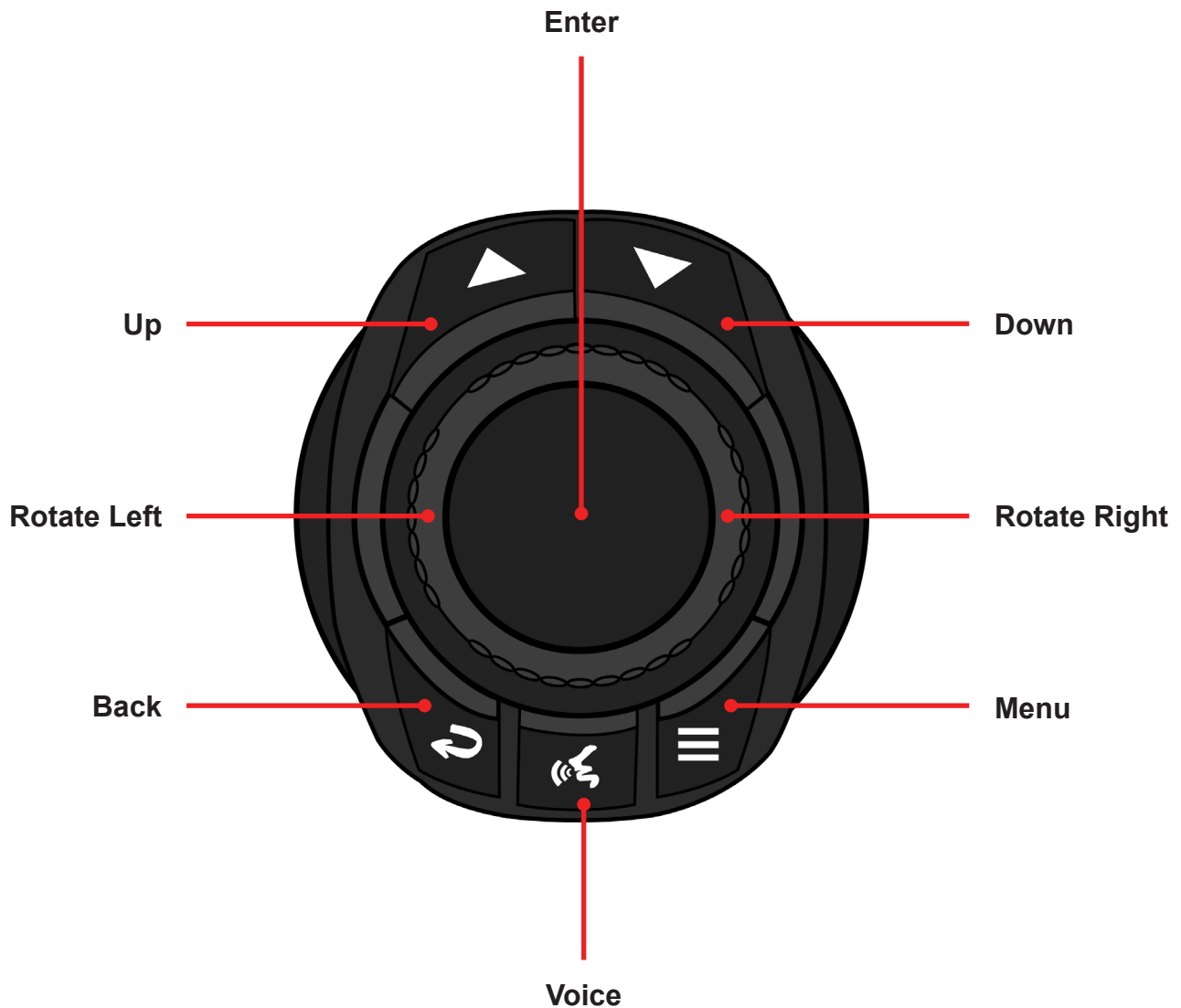

Up- Go up inside Apple CarPlay or Android Auto.

Down- Go down inside Apple CarPlay or Android Auto. In Android Auto, down button is used to enter the bottom menu bar of Android Auto.

Rotate Left- Go left inside Apple CarPlay or Android Auto.

Rotate Right- Go right inside Apple CarPlay or Android Auto.

Back- Go back inside Apple CarPlay or Android Auto. Press and hold for 3-5 seconds to turn the interface ON or OFF.

Voice- Press to activate Siri or Ok Google.

Menu- Brings up interface's bottom menu to change inputs or go into settings.

Enter- Enters into apps or menus.

Audio Steering Wheel Controls

Audio Steering Wheel Controls

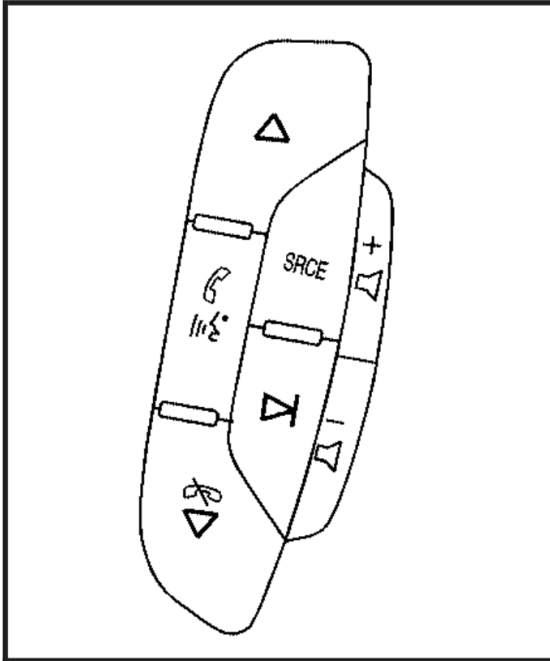

Vehicles with audio steering wheel controls could differ depending on the vehicle's options. Some audio controls can be adjusted at the steering wheel.

Steering wheel buttons can be used with Apple CarPlay/Android Auto, when interface is activated buttons are repurposed for the interface use.

△ (Next): Press to go to the next track

▽  (Previous/End): Press to go to the previous track, or press to end a current call

  (Mute/Push to Talk): Press to activate Siri or Ok Google, or press to answer a call

SRCE (Source/Voice Recognition): Press to change interface inputs