

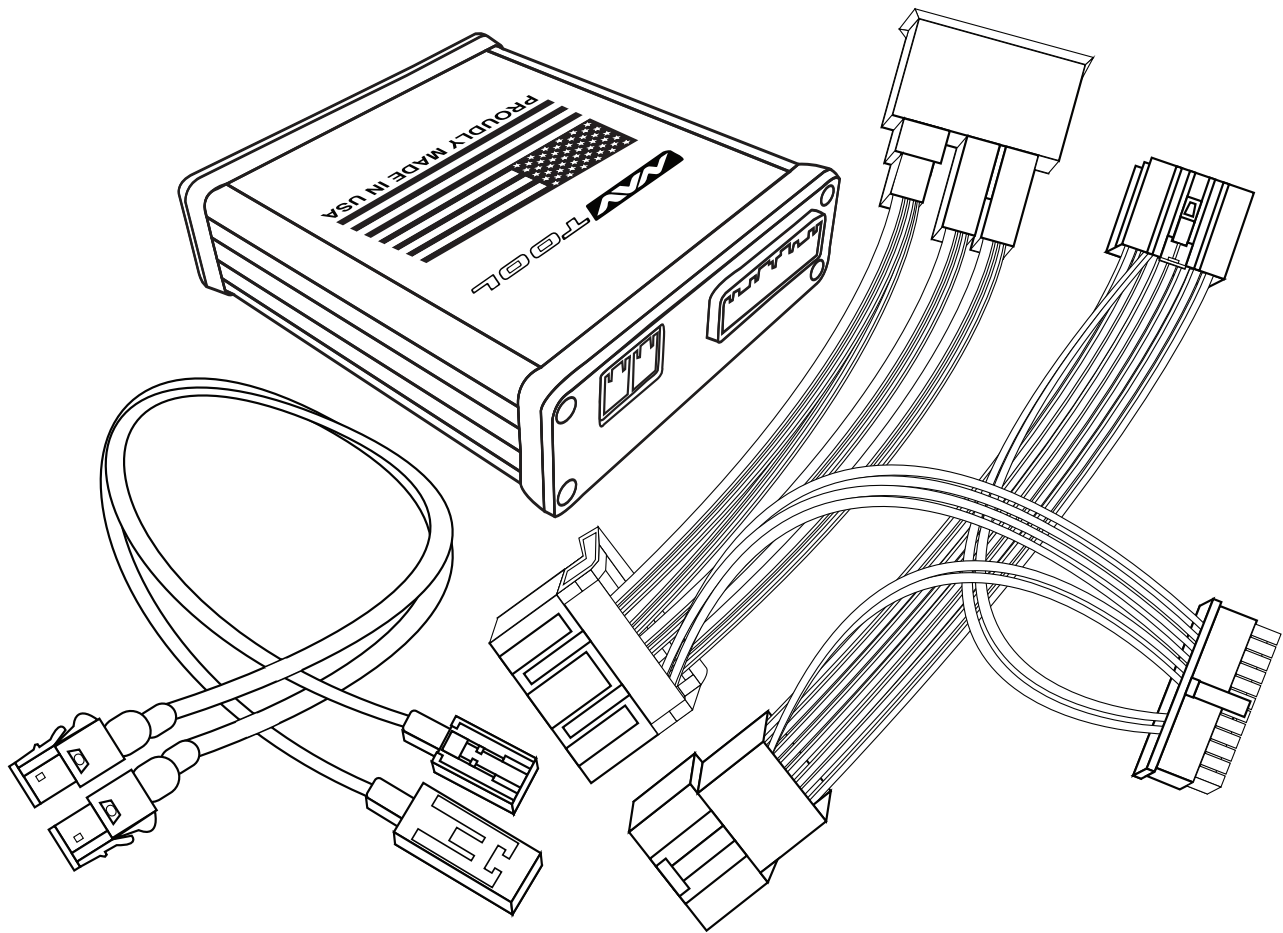

# Installation Manual

## Buick LaCrosse 2010-2013



### Interface with HDMI Mirroring

### Part #: NAVTOOL6.0-LG1

*NOTICE: Navtool recommends having this installation performed by a certified technician.  
Logos and trademarks used here in are the properties of their respective owners.*



**Buick LaCrosse 2010-2013**

# WELCOME

## IMPORTANT WARNING

This product includes instructions for installation, which must be carefully followed. The instructions are worded in such a manner to assume that the installer is capable of completing these types of electronic installations. Suppose you are unclear about what you are instructed to do or believe you do not understand the instructions to complete the installation properly and safely. In that case, you should consult a technician who has this knowledge and understanding. Failure to follow these instructions carefully and install the interface as described could cause harm to the vehicle or safety systems on the vehicle. Interference with specific safety systems could cause damage to persons as well.



## NEED HELP?



Open the camera app on your smartphone and point your rear camera at the QR-Code to scan it. Finally, tap the pop up banner to open support website.

# Table of Contents

## Installation Instructions

<a href="#">Precautions</a>	3
<a href="#">What's In The Box</a>	4
<a href="#">Interface Connectors Description</a>	5
<a href="#">Universal Harness Description</a>	6
<a href="#">Quick Connection Guide</a>	7-8
<a href="#">Installation Instructions</a>	9-16
<a href="#">Testing and Settings</a>	17-20

## Extra Details

<a href="#">Vehicle Reassembly Checklist</a>	21
<a href="#">Video Interface Menus</a>	22-28
<a href="#">Connect Rear Screens With AV Input</a>	29
<a href="#">Connect Rear Screens With HDMI Input</a>	30

## User Manual

<a href="#">User Manual</a>	End Pages 1-4
-----------------------------	---------------

Print End Pages 1-4  
and give them to the customer

# Precautions

---

## PLEASE READ BEFORE YOU START THE INSTALLATION

- Please study these instructions carefully before installing NavTool interface.
- Many new vehicles use low-voltage or data-bus systems that can be damaged by test lights and logic probes. Test all circuits with a digital multi-meter before making connections.
- Do not disconnect the battery if the vehicle has an anti-theft-coded radio, unless you have the radio code.
- If installing an external push button switch, check with the customer about where to install the switch.
- To avoid accidental battery drainage turn off the interior lights or remove the dome light fuse.
- Roll down a window to avoid being locked out of the car.
- Use of this product in a manner different to its intended way of operation may result in property damage, personal injury, or death.
- Set Parking brake.
- Remove the negative battery cable.
- Protect fenders before starting.
- Using protective blankets to cover front seats, interior of the vehicle and center console.
- Always install a fuse 6-12 inches away from NavTool interface, 5 amp fuse should be used.
- Always secure NavTool interface with Velcro or double side tape to prevent rattling of the interface.
- When securing NavTool interface make sure that panels can be closed back easily.
- Use electrical tape on all you connections and splices, do not leave any exposed connections.
- Route all wires along factory harnesses, try not to drill or make any unnecessary holes.
- Make sure you are not connecting to any data wires; always check your connections with a multi-meter.
- Always use help of a professional installer to prevent any damage to the vehicle or NavTool interface.

# What's In The Box?

NavTool Interface  
(Part # NAVTOOL6.0-LG1)

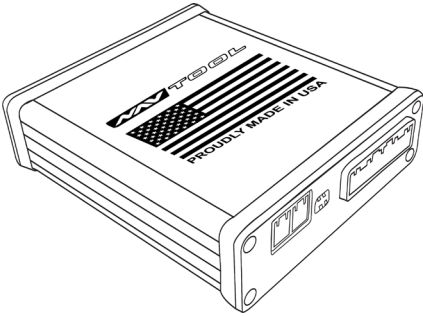

NavTool LVDS Cables  
(Part # NT-GMBLU-LVDS)

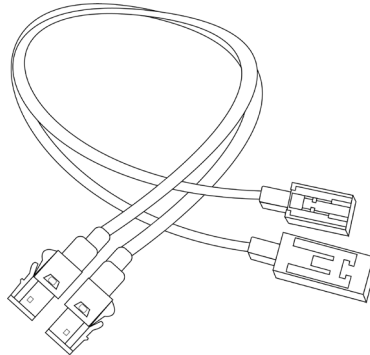

USB Configuration Cable  
(Part # NT-USB-CNG)

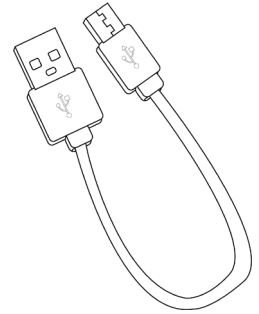

NavTool Interface Harness  
(Part # NT-WHNT6)

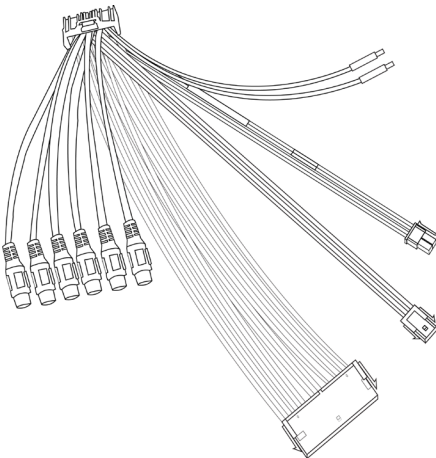

NavTool Vehicle Specific  
Plug and Play Harness  
(Part # NT-GMQUAD-BLU)

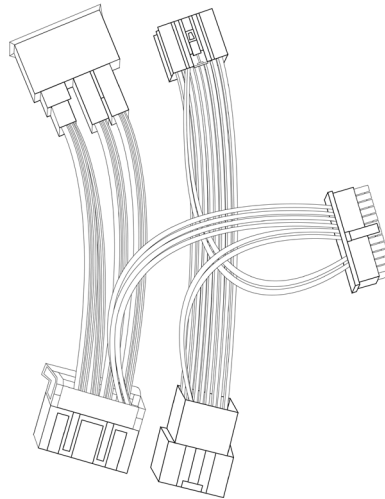

NavTool AUX Activator  
(Part # NT-AUX-ACT)

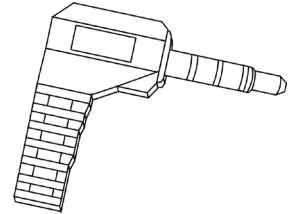

# Interface Connectors Description

## NavTool Interface (Part # NAVTOOL6.0-LG1)

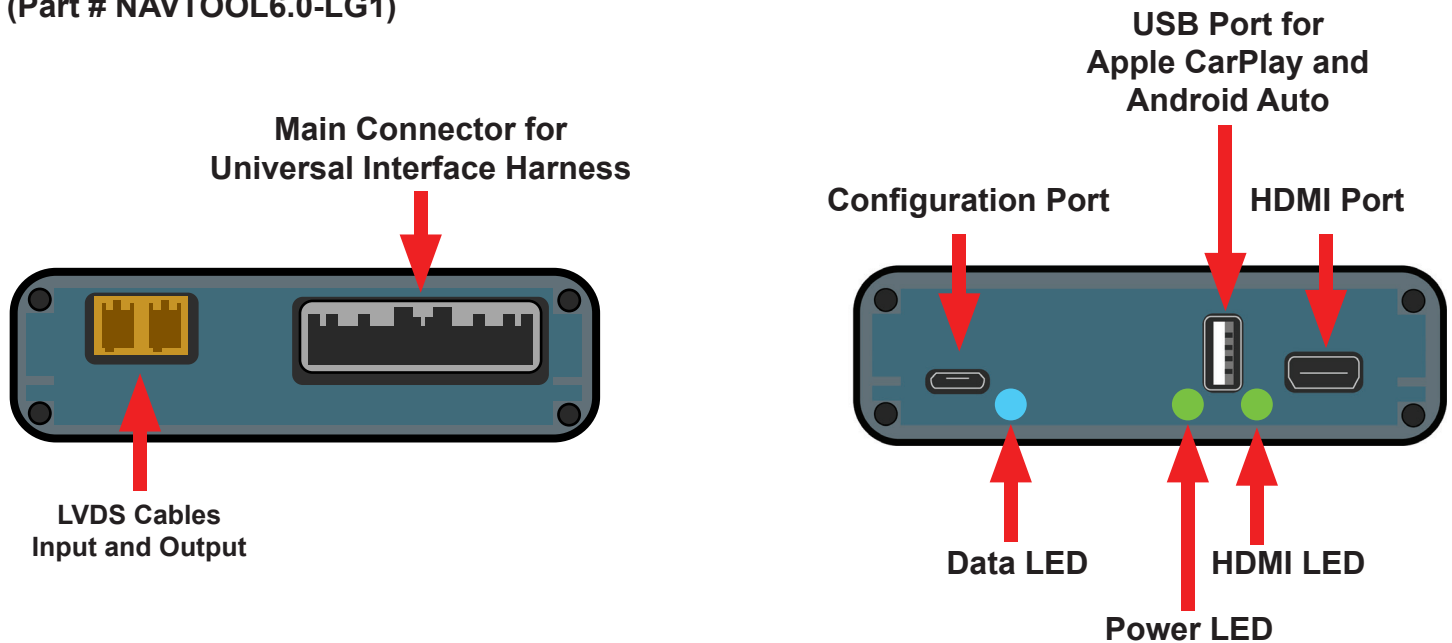

**Main Connector for Universal Interface Harness-** This port is dedicated for a connection of a universal wiring harness

**LVDS Cables Input and Output-** This port is dedicated for the LVDS cables.

**Configuration Port-** This USB port is dedicated for the interface configuration only.

**Data LED-** Normal operation of the interface must have blue LED blinking. If the blue LED is not blinking, the interface is not receiving data from the vehicle. If the blue LED is not blinking, the interface will not operate properly.

**Power LED-** Normal operation of the interface must have a green LED ON. If the green LED is not ON, the interface is not receiving power. If the green LED is not ON, the interface will not work, and your vehicle radio may also stay OFF.

**HDMI LED-** Normal operation of the interface must have a green LED ON. If the green LED is not ON, the interface HDMI is not receiving power. If the green LED is not ON, the interface HDMI port will not work.

**USB Port for Apple CarPlay and Android Auto-** Not Used

**HDMI Port-** HDMI port is dedicated for connecting video sources such as iPhone mirroring, Android Mirroring, Apple TV, Roku, FireStick, Chromecast, PlayStation, Xbox, or similar devices.

# Universal Harness Description

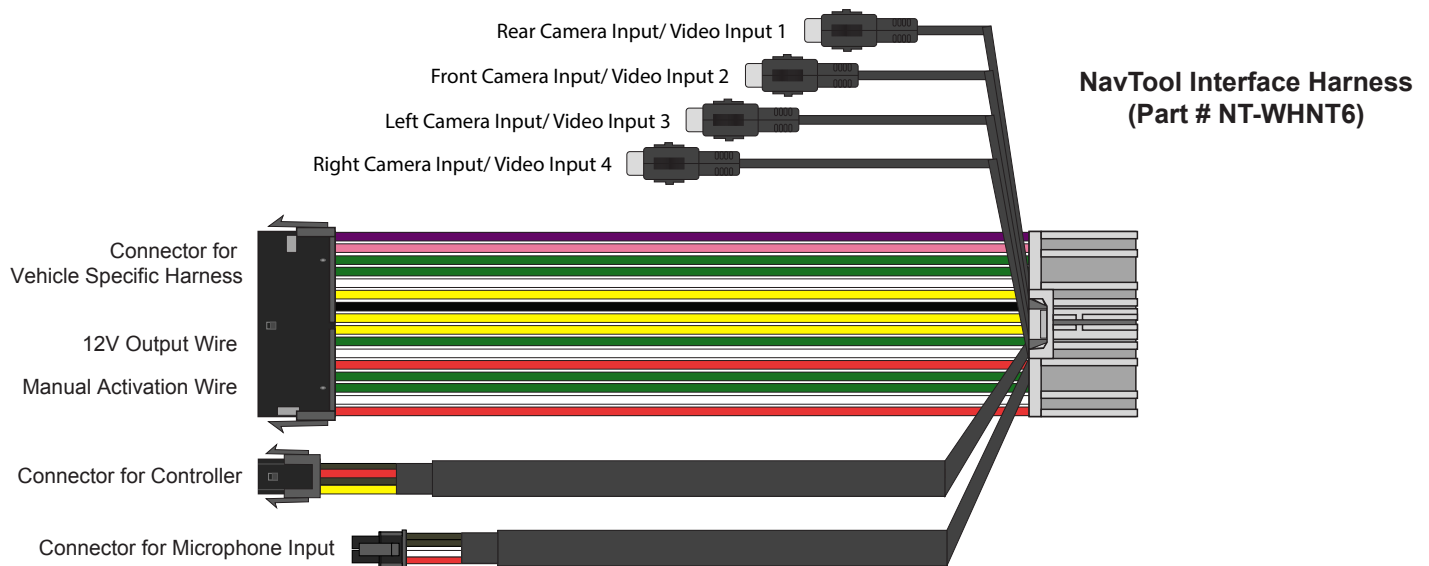

**Rear Camera Input /Video Input 1-** This input is dedicated for an aftermarket rearview camera or a video source with an RCA video output. Your vehicle factory camera will continue to work as before without any changes.

**Front Camera Input /Video Input 2-** This input is dedicated for an aftermarket front view camera or a video source with an RCA video output. Your vehicle factory camera will continue to work as before without any changes.

**Left Camera Input / Video Input 3-** This input is dedicated for an aftermarket left view camera or a video source with an RCA video output. Your vehicle factory camera will continue to work as before without any changes.

**Right Camera Input / Video Input 4-** This input is dedicated for an aftermarket right view camera or a video source with an RCA video output. Your vehicle factory camera will continue to work as before without any changes.

**Connector for Vehicle Specific Harness-** This connection is dedicated for connecting vehicle specific plug and play wiring harness.

**Connector to Controller-** Not Used

**Connector for Microphone Input-** Not Used

**+12V Manual Activation Input-** This connection is used only if the factory rearview camera is not operating correctly in reverse. In that case, this wire must be connected to the vehicle's reverse +12V output. (Change setting "Manual Activation Wire as +12V Reverse Input" See page 41)

**+12V Output-** 500 mA output can be used to drive a relay. This output provides +12V at all times when the vehicle is running.

# Quick Connection Guide

See Page 8

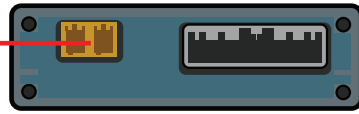

NavTool Interface  
(Part # NAVTOOL6.0-LG1-NBT)

Click



NavTool Supplied Harness  
(Part # NT-WHNT6)

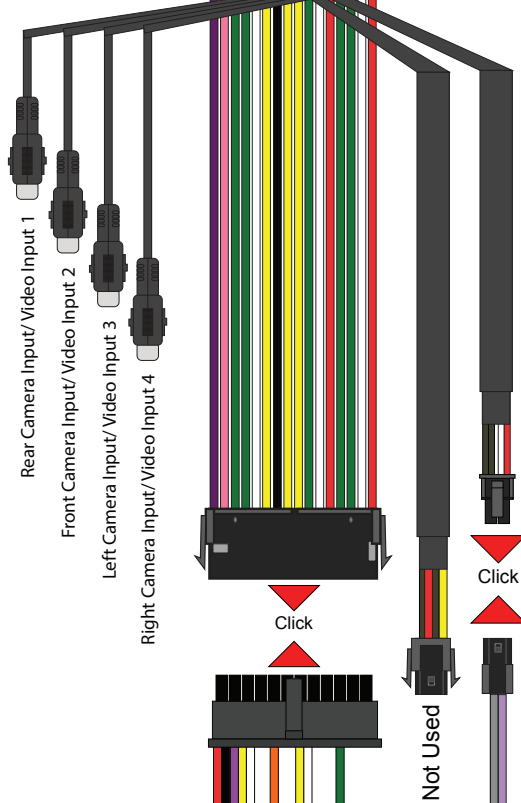

Click

Click

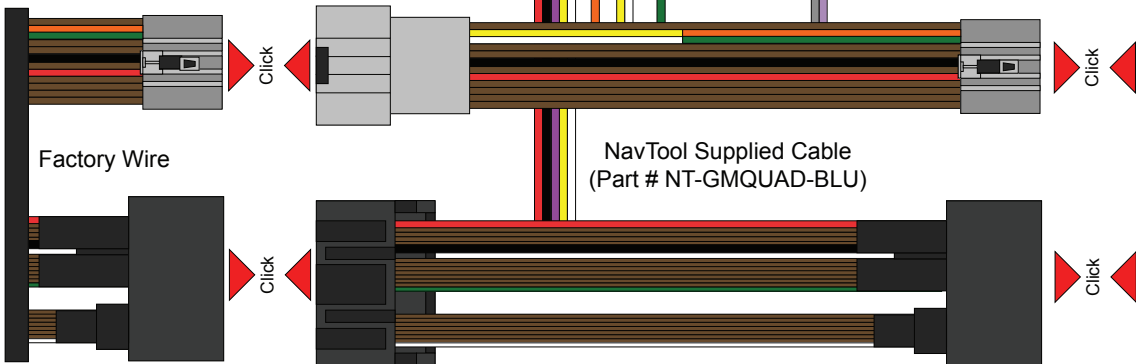

Click

Click

Click

Click

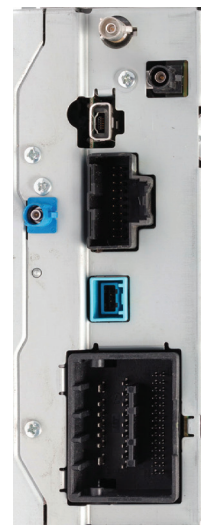

Back of Car Radio

# Quick Connection Guide

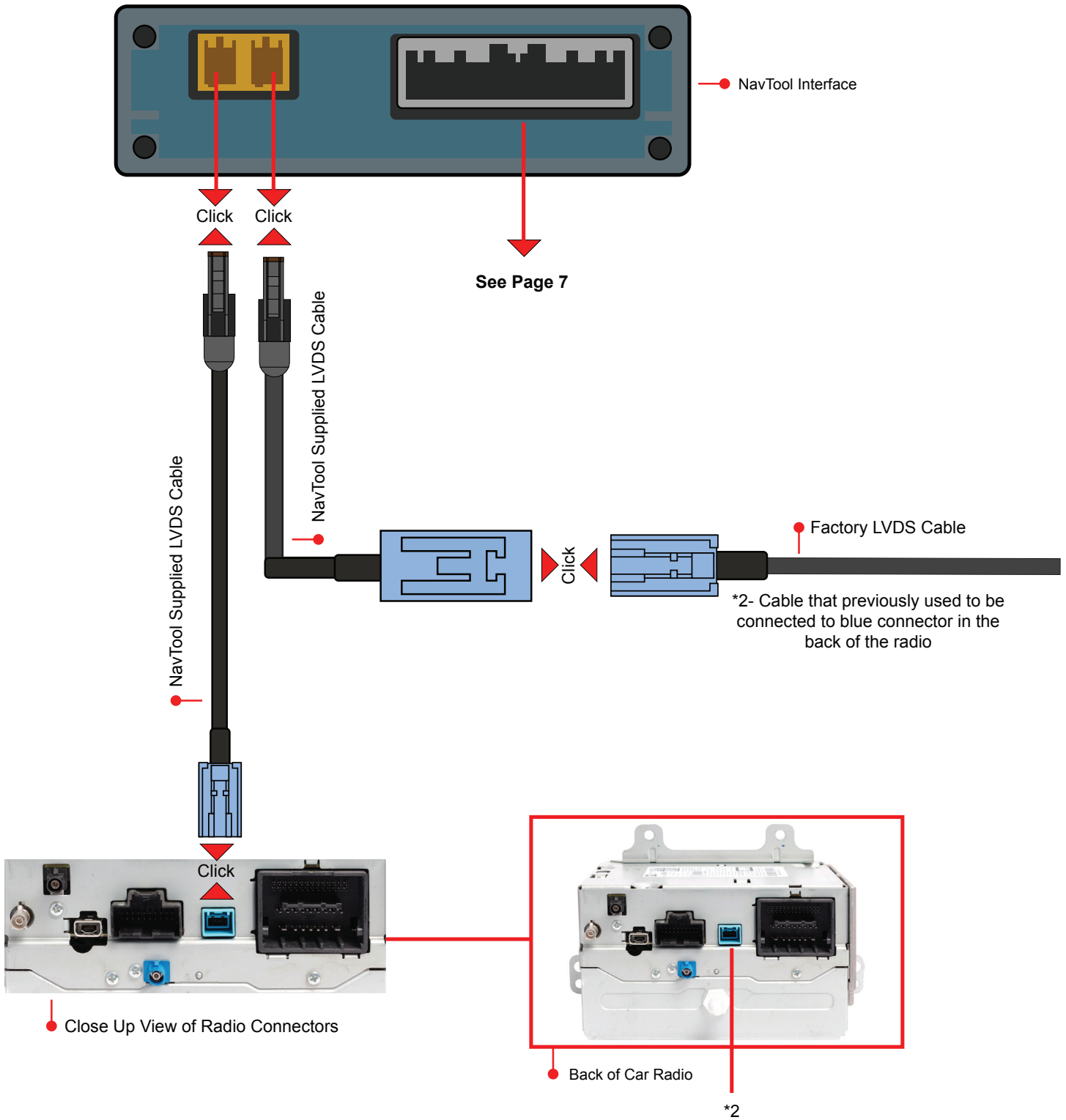



# Installation Instructions

## STEP 1

**NO APPLICATION OR SOFTWARE DOWNLOAD IS REQUIRED TO CONFIGURE THE INTERFACE.**

To configure the interface, you must use Windows, Mac, or Google computer.

Windows computers must use the latest version of Google Chrome or Microsoft Edge browser.

Mac computers must use the latest version of the Google Chrome browser.

Google computers must use the latest version of the Google Chrome browser.

**TO CONFIGURE THE INTERFACE, GO TO [HTTPS://CONFIG.NAVTOOL.COM](https://config.navtool.com)**

Connect the interface to the computer using supplied USB Configuration Cable (Part # NT-USB-CNG)

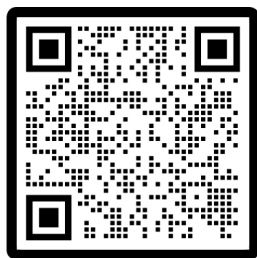
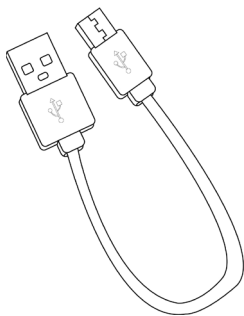

SCAN ME

To see a video of the configuration process  
Scan QR-Code or go to  
[https://youtu.be/iES\\_rW240X0](https://youtu.be/iES_rW240X0)

## STEP 2

**Remove Vehicle Navigation Radio or Color Screen**

**List of Required Tools:**

1. Plastic Panel Removal Tool- Example of a removal tool is shown below. Any similar removal tool will do the job. It does not need to be the same as the picture below.
2. 7 mm Socket- Example of a 7 mm socket tool is shown below. Any similar tool will do the job. It does not need to be the same as the picture below.



# Installation Instructions

## STEP 2 Continued

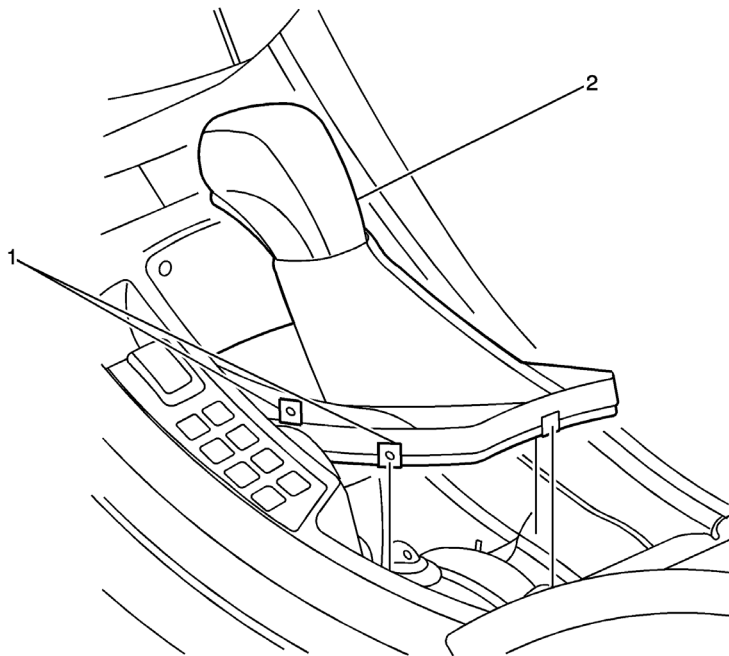

### Step 1: Transmission Control Lever Knob Retainer (Qty: 12)

- Use a flat-bladed plastic trim tool in order to release the retainer clips securing the control lever boot.

### Transmission Control Lever Knob

- The control lever boot and knob are replaced as an assembly.
- To remove the knob, pull upward and twist.

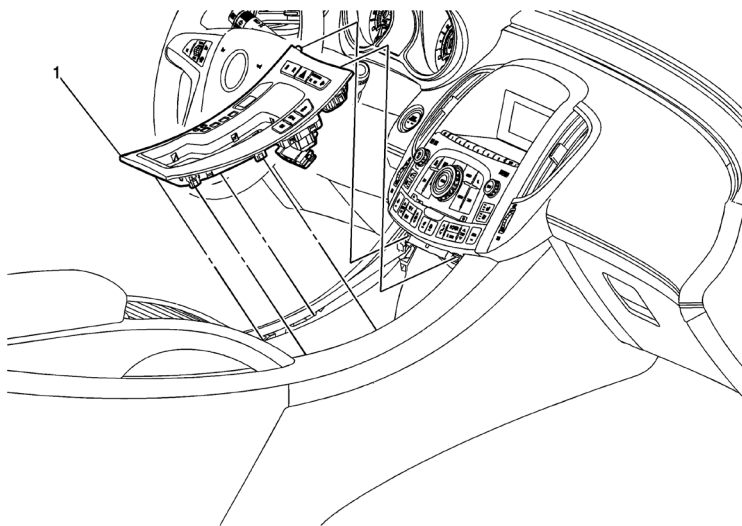

### Step 2: Automatic Transmission Control Indicator Bezel Assembly

- Use a flat bladed plastic trim tool in order to release the retainer clips securing the automatic transmission control indicator bezel to the console assembly.
- Disconnect electrical connections.

# Installation Instructions

## STEP 2 Continued

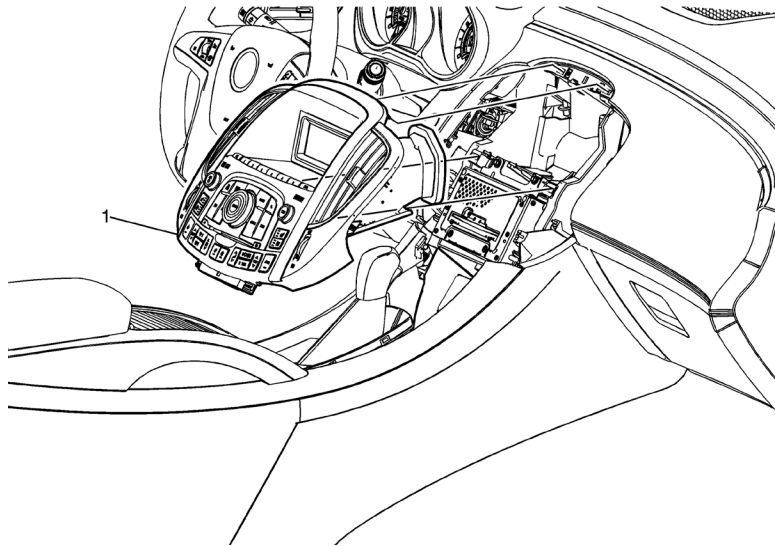

### Step 3: Instrument Panel Trim Plate Applique Assembly

**Caution:** Use care to avoid contact with the two metal springs clips around the Driver Information Display when removing the Instrument Panel Upper Center Trim Panel. Contact with these clips can damage the surface of the Driver Information Display. Failure to carefully remove/install the Instrument Panel Upper Center Trim Panel can lead to Driver Information Display lens damage.

- Use a flat bladed plastic trim tool in order to release the retainer clips securing the instrument panel upper center trim panel to the instrument panel assembly.
- Disconnect electrical connections.

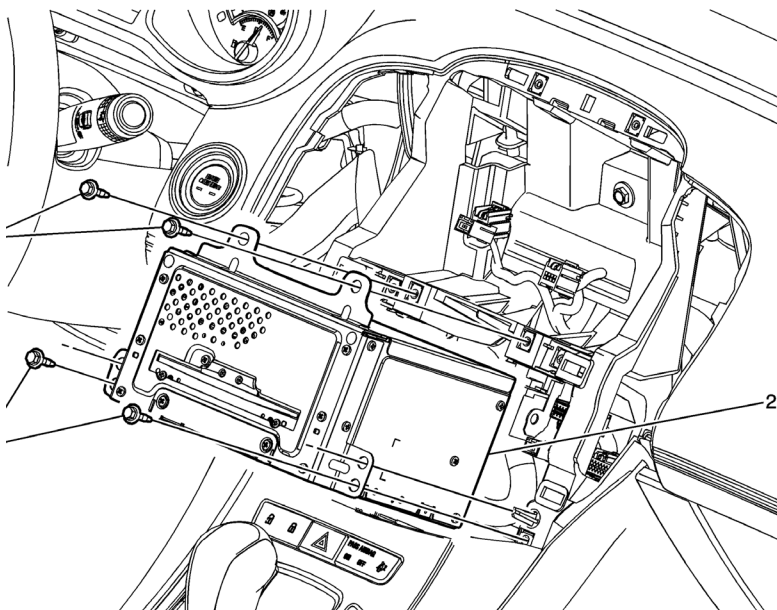

### Step 4:

**Note:** The Center of the Radio Assembly may have a mounted Bluetooth Antenna. Do not touch or apply any pressure to the Bluetooth Antenna during removal or installation.

- Radio Fastener (Qty: 4 )
- Disconnect the electrical connections.

# Installation Instructions

## STEP 3

**Step 1:** Connect supplied plug and play harness (Part # NT-GMQUAD-BLU) to the back of the radio.

**Step 2:** Connect factory connectors into the supplied vehicle specific plug and play harness.

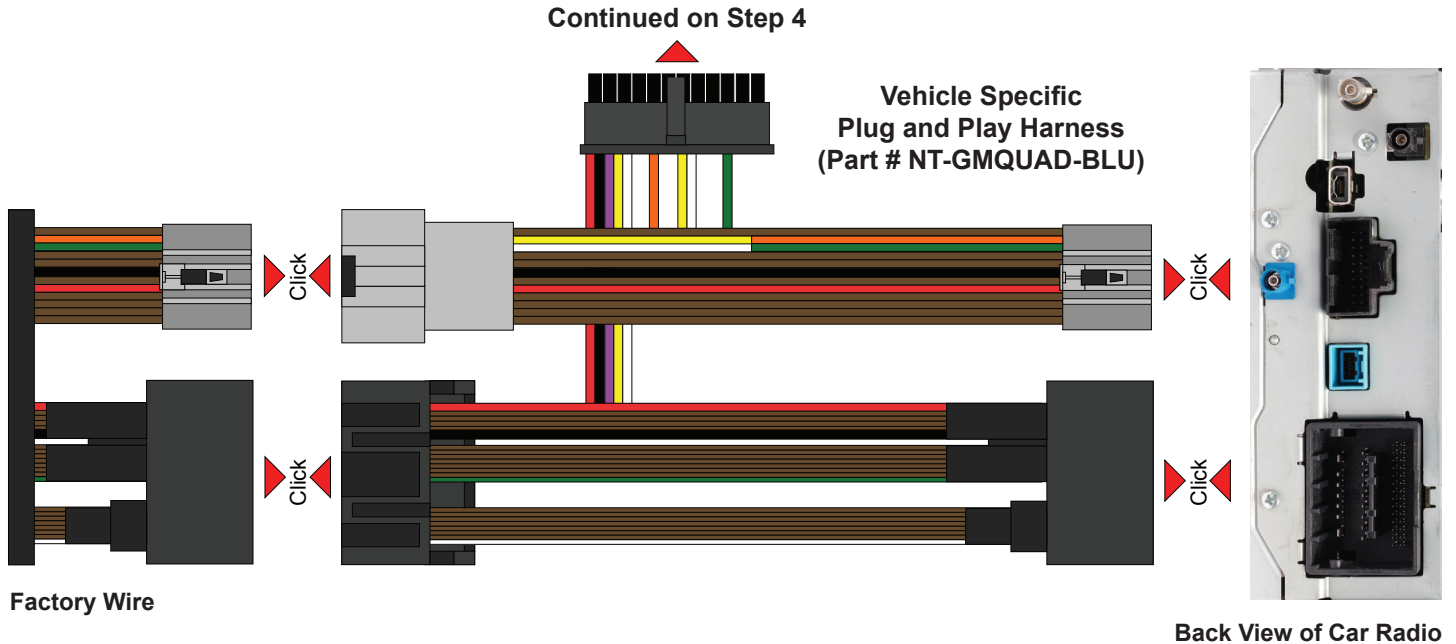

(For complete image, see Quick Connection Guide on page 7)

**Step 2:** Reconnect previously removed radio connectors into the back of the radio.

## STEP 4

Connect supplied universal wiring harness (Part # NT-WHNT6) into plug and play harness (Part # NT-GMQUAD-BLU).

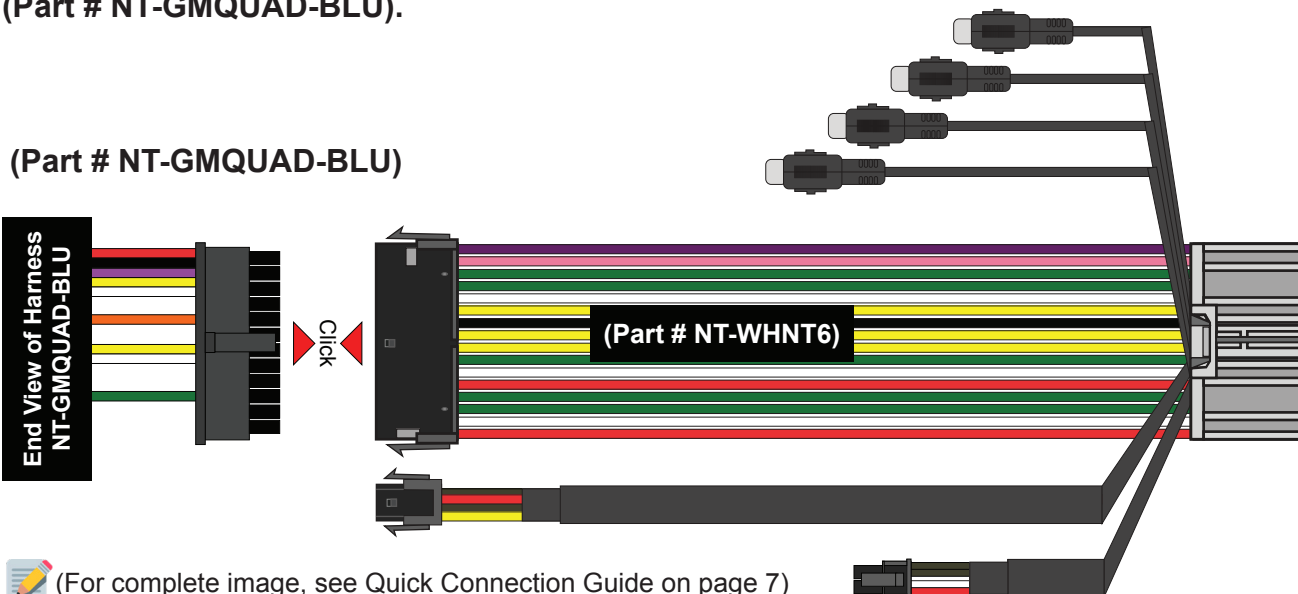

(For complete image, see Quick Connection Guide on page 7)

# Installation Instructions

## STEP 5

**Step 1:** Connect the 4 pin plug from the vehicle specific supplied harness (Part # NT-GMQUAD-BLU) to the 4 pin microphone input connector on the NavTool Interface Harness (Part # NT-WHNT6).

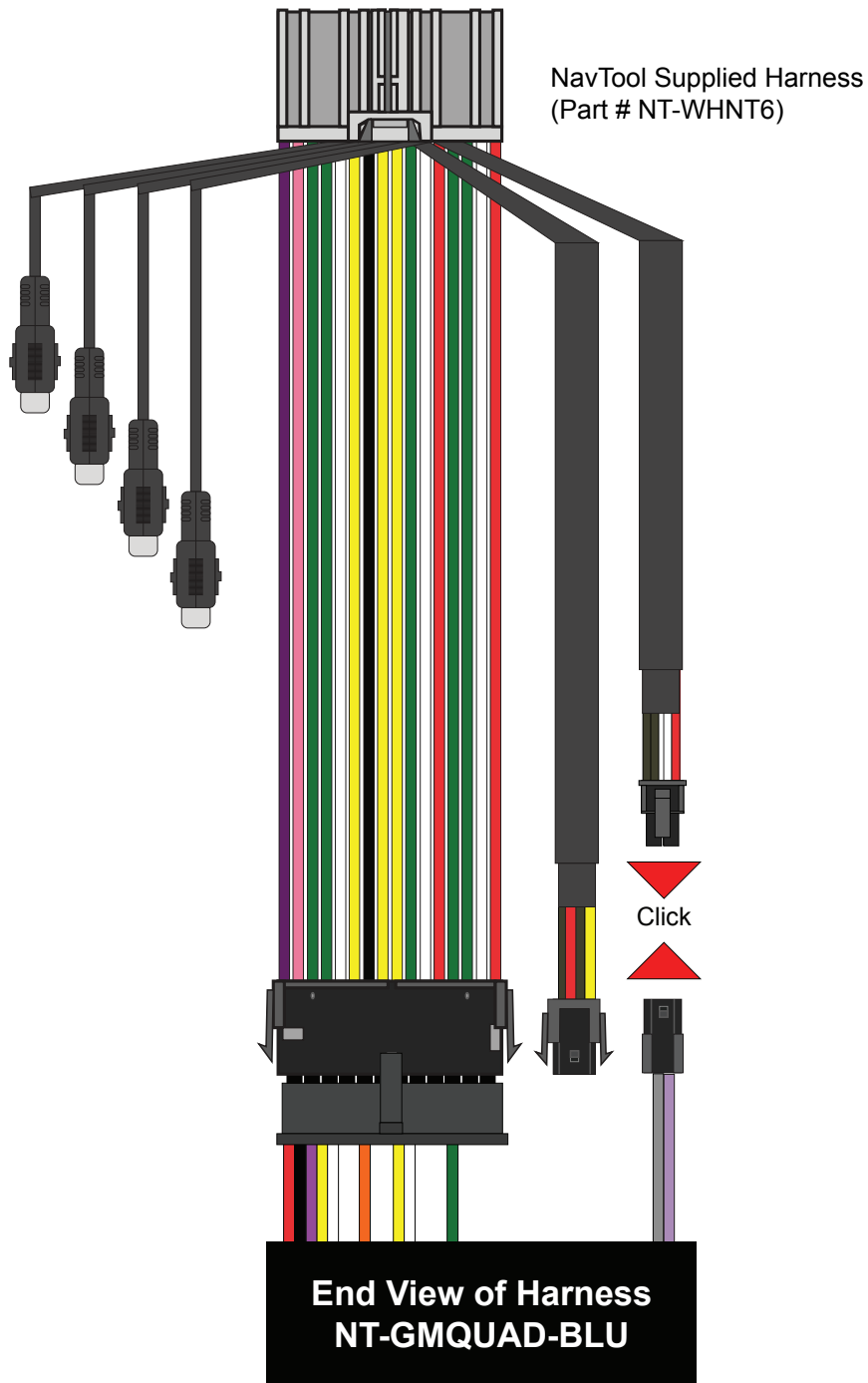



# Installation Instructions

## STEP 8

Plug the universal wiring harness (Part # NT-WHNT6) into in main interface (Part # NAVTOOL6.0-LG1-NBT) into. See quick connection guide on page 7.

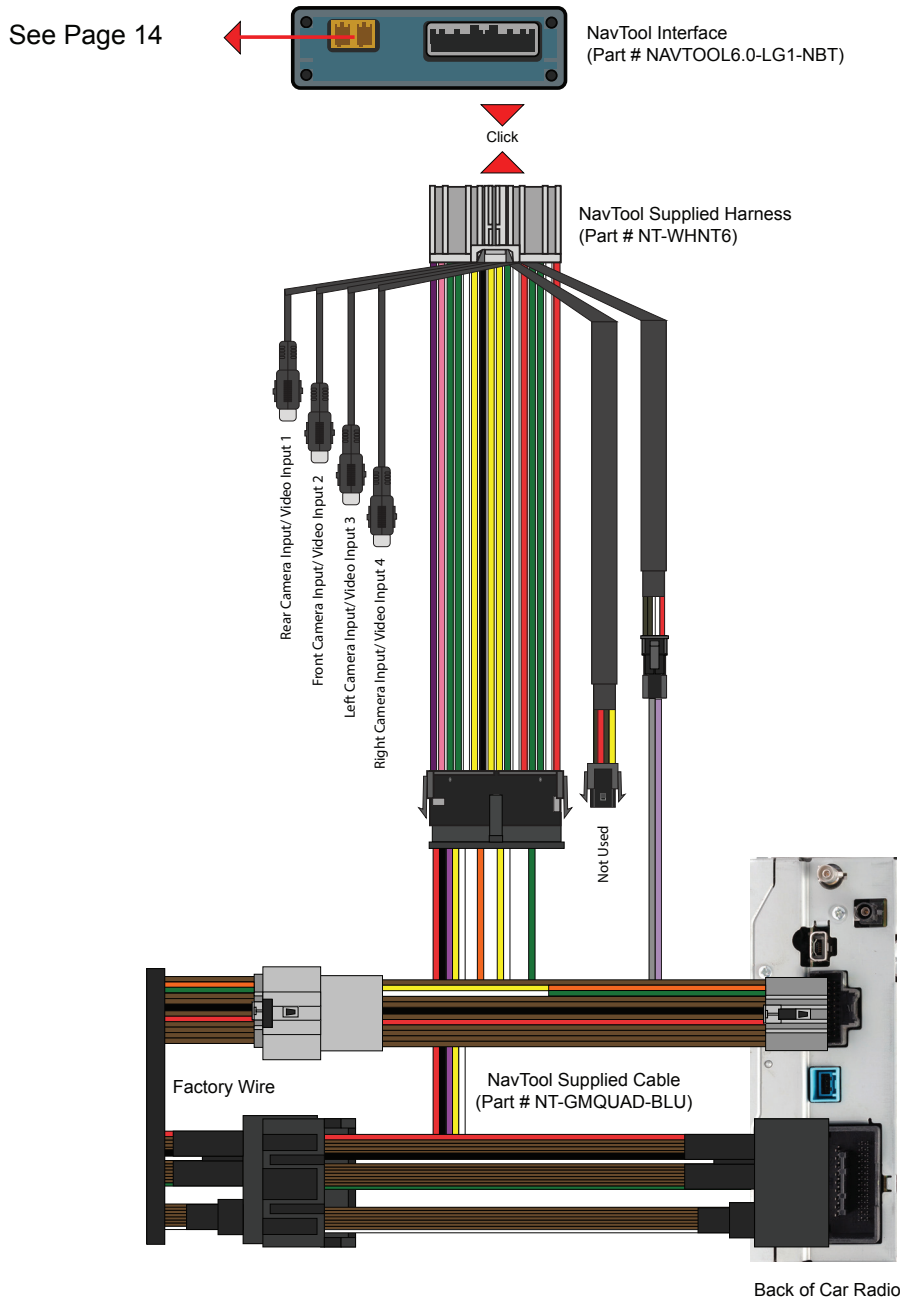

- The NavTool interface installation is now complete.
- Do not reassemble the vehicle until testing is fully complete. Only after you have tested that everything is working can you reassemble the car.
- If you are adding side or front cameras, install them and plug them into the appropriate camera RCAs.
- If you are installing any HDMI or streaming devices, connect it to the HDMI port of the NavTool.

# Installation Instructions

## STEP 9

Plug the NavTool supplied AUX Activator (Part # NT-AUX-ACT) into vehicle's 3.5mm AUX jack. See image below.

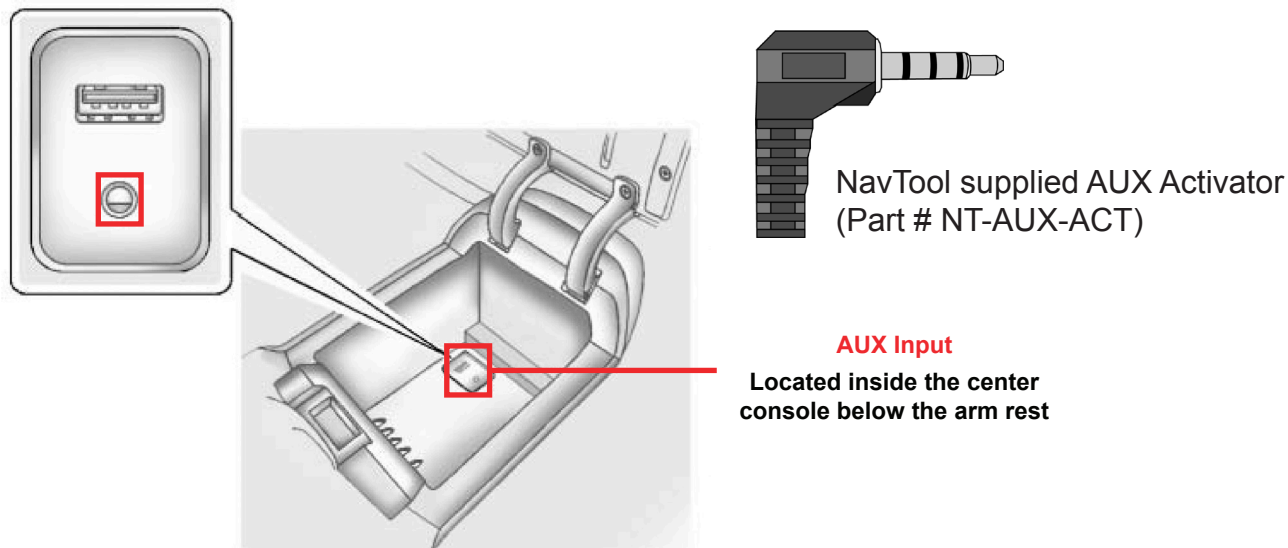

## STEP 10

After the interface is installed and you activate the NavTool, if your screen is blinking or you see a NavTool image for a second and it goes to a black screen, you must cut a wire on the harness.

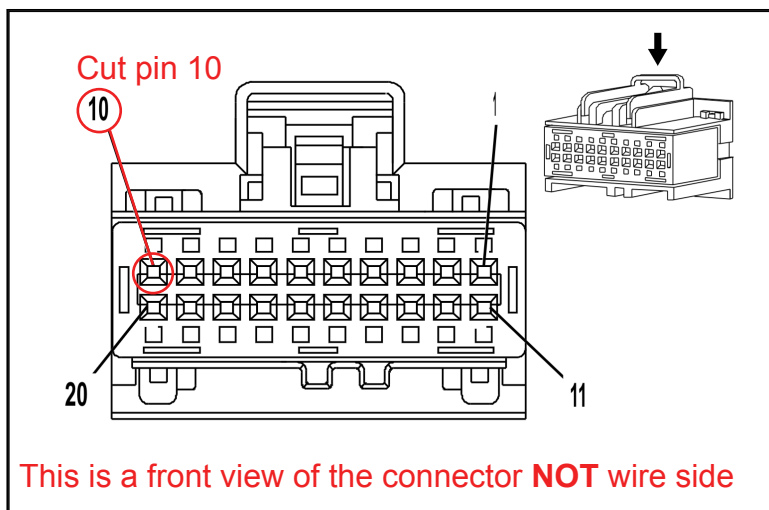



# Testing and Settings

## STEP 1

- Start the car, observe NavTool LED lights should be one blinking blue and two steady lit green LED lights.

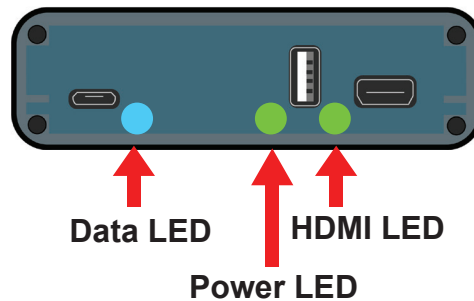

- At this time, your car radio should boot up into its initial state, and the radio should be working. Please check that the radio operates appropriately. All radio functions are working, including CD, Satellite Radio, AM/FM radio, audio plays from car speakers, and all other radio features.

## STEP 2

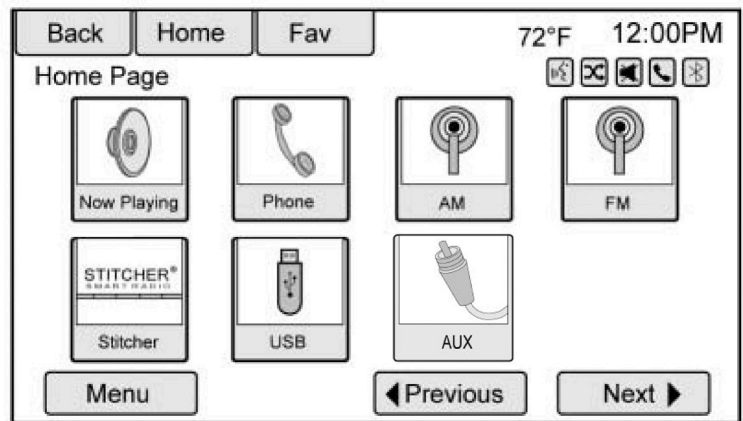
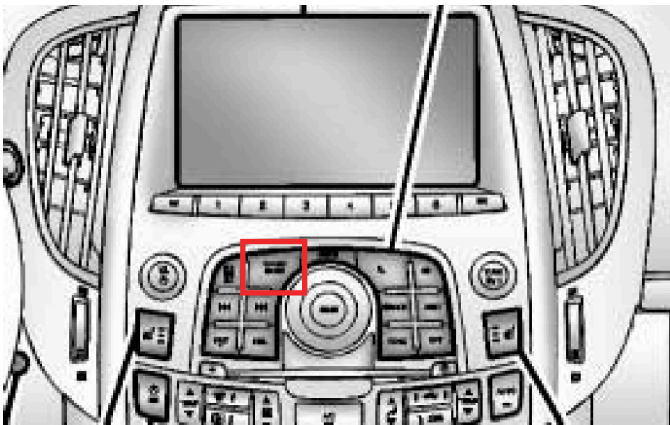

### Set Radio to AUX Audio Input:

- SRCE Button: Press the SRCE button to display the audio screen. Press to switch between AM, FM, or XM, if equipped, Disc, or AUX (Auxiliary). Must set a radio to auxiliary/AUX before activating NavTool to hear audio from car speakers.
- Audio will not play through car speakers if AUX activator jack is not connected or radio is not set to AUX input.

# Testing and Settings

## STEP 3

- Press and hold one of the four corners with your thumb for 3 seconds to activate the interface. The preferred corner is the top right. You should hear a chirp, and after that, the interface will start, and the NavTool menu will appear on the screen. After activating the interface, the NavTool screen will show (see Fig.2)

 After the interface is installed and you activate the NavTool, if your screen is blinking or you see a NavTool image for a second and it goes to a black screen, you must cut a wire on the harness. (See Page 16)



Fig. 1



Fig. 2

## STEP 4

Adjust camera inputs if you haven't done so already during the initial configuration of the interface.



- Touch the settings menu option.
- The menu option is the last icon on the bottom right.

Step: 1



- Touch the settings gear.
- The settings gear is the top icon.

Step: 2

MISCELLANEOUS SETTINGS	ON	OFF
APPLE CARPLAY / ANDROID AUTO (AUTO ON MODE)	<input checked="" type="radio"/>	<input type="radio"/>
INTERFACE AUDIO SOUND	<input checked="" type="radio"/>	<input type="radio"/>
MANUAL ACTIVATION WIRE AS REVERSE TRIGGER +12V	<input type="radio"/>	<input checked="" type="radio"/>
	SAVE	CANCEL

To change features ON or OFF, touch the text on the screen that is indicated in the image with the dotted outline.

- Touch the text "Manual Activation Wire as Reverse Trigger +12V."
- Change the setting to OFF, once the red dot is set to OFF (image shown on the left), click the SAVE button on the bottom right.



Apple CarPlay/Android Auto (Auto ON Mode) only set it to ON if you do not plan to use HDMI or video inputs

Step: 3

# Testing and Settings

## STEP 5



### Camera Settings

- Touch the Camera Settings icon.

#### Step: 1

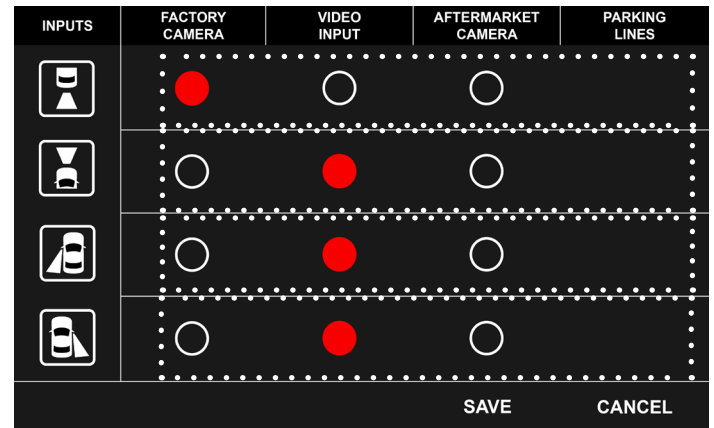

### Camera Settings

- Image above shows you typical camera settings.
- To change camera input, touch the desired line of the camera as indicated in the image above. (rear, front, left, or right). Tap repeatedly to change the options for your camera input.
- Once all camera inputs are set, tap the SAVE button on the bottom right.

#### Step: 2

To change the camera input settings, touch the area on the screen that is indicated in the image with the dotted outline.



Set vehicle in reverse gear to test the operation of the factory rear view camera.



Press and hold one of the four corners of the touch screen for 3 seconds to turn OFF the NavTool interface. Press and hold the corner of the touch screen for a few seconds until the bottom menu appears on the screen, release the finger and hold the corner of the screen again to return to the factory menu. (See page 18 for details)

# Testing and Settings

## STEP 6

- Test HDMI input if you are connecting any HDMI video source. To bring up the bottom menu, press and hold one of the four touch screen corners for 3 seconds.



- Touch the HDMI button on the screen to enter the HDMI input of the interface.
- Video signal from your HDMI source will appear on the screen.

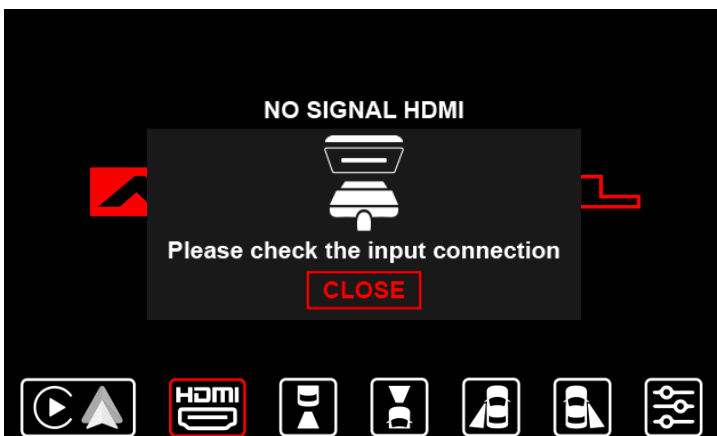

- If no video source is connected or the connected source is not correctly working, you will see this message. (Image shown above)
- Test AV inputs by selecting them in the menu of the interface or if you are installing any aftermarket cameras.
- To test aftermarket front camera, put the car in reverse then into drive. Front camera should display on the screen.
- To test aftermarket left and right cameras, use left and right turn signals. Left and right cameras should display depending on the turn signal activated.
- To exit HDMI input or any Camera inputs, tap the touch screen to bring up the bottom menu.



After everything is tested and working, reassemble the vehicle.

# Vehicle Reassembly Checklist

When performing vehicle reassembly, please make sure to go over the list and checkoff check mark boxes:

- Check to see if all connectors behind the screen, radio, HVAC etc. were reconnected.
- Check that LCD screen shuts off with the key off, and turns back on with the key on.
- Check touchscreen operation.
- Check Heat and AC controls operation.
- Check AM/FM/SAT radio reception.
- Check CD player/changer operation.
- Check GPS signal reception.
- Check cigarette lighter or +12V power source for accessory or constant power.
- Check to see if any other panels that were removed during installation and now being reassembled have all and any electrical connectors reconnected.
- Turn on parking light and check all dashboard lights operation.
- Check all panels for proper fit, make sure no gaps in panels are left behind.

If all steps above are checked off, you will save time, money and have an extremely happy customer.

All above steps eliminate any unnecessary customer comebacks to your shop.

If you require any further assistance please call our tech support line, email or go online

WWW.NAVTOOL.COM

1-877-628-8665

techsupport@navtool.com

# Interface Menus and Settings



NavTool Interface Screen

Press and hold one of the four corners of the touch screen to activate or deactivate NavTool interface. After you activated the interface, you will be brought to this screen that you can navigate using the factory touch screen. (See page 18)

# Interface Menus and Settings



## Apple CarPlay/Android Auto

Tap the Apple CarPlay/Android Auto button to enter the option.

After selecting Apple CarPlay/Android Auto you will be brought to your Apple CarPlay/Android Auto screen.

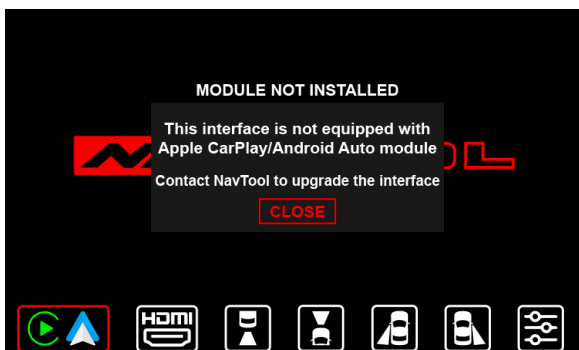

## Apple CarPlay/Android Auto Module Not Installed

You will get this message when selecting this option on the NavTool interface that is not equipped with Apple CarPlay/Android Auto module.



## HDMI

Tap the HDMI button to enter this option.

After selecting HDMI with a HDMI source attached, you will be brought to your HDMI's device screen and connected image will appear on the screen.

To exit HDMI, tap the touch screen to bring up the bottom menu.

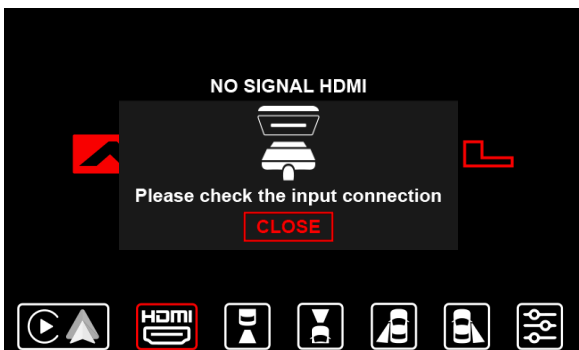

## No HDMI Signal

You will get this message when selecting this input with no HDMI source connected to interface.

# Interface Menus and Settings



## Back-Up Camera

Tap the Back-Up Camera button to enter this option.

After selecting the back-up camera input, you will be brought to your back up camera screen. This will not work if a back-up camera is not installed. (Note: This input will not display factory installed rear-view camera)

To exit Back-Up Camera, tap the touch screen to bring up the bottom menu.



## Front Camera

Tap the Front Camera button to enter this option.

After selecting the front camera input, you will be brought to your front camera screen. This will not work if a front camera is not installed. (Note: This input will not display factory installed forward facing camera)

To exit Front Camera, tap the touch screen to bring up the bottom menu.

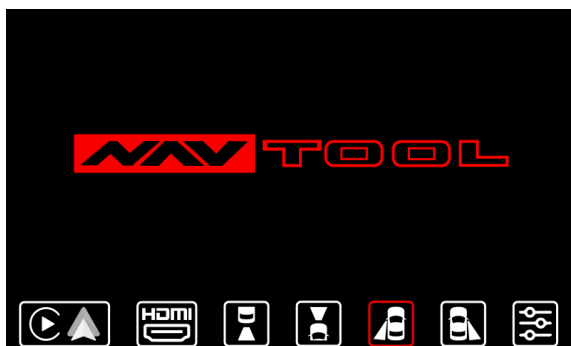

## Left Lane Watch Camera

Tap the Left Lane Watch Camera button to enter this option.

After selecting the left lane watch camera input, you will be brought to your left lane watch camera screen. This will not work if a left lane watch camera is not installed. (Note: This input will not display factory installed left lane watch camera)

To exit Left Lane Watch Camera, tap the touch screen to bring up the bottom menu.



## Right Lane Watch Camera

Tap the Right Lane Watch Camera button to enter this option.

After selecting the right lane watch camera input, you will be brought to your right lane watch camera screen. This will not work if a right lane watch camera is not installed. (Note: This input will not display factory installed right lane watch camera)

To exit Right Lane Watch Camera, tap the touch screen to bring up the bottom menu.



# Interface Menus and Settings



## Settings

Tap the Settings Menu button to enter this option.

After selecting the settings option, a menu will expand showing different interface settings you can change.



## Settings Options Menu

The Settings Menu button will change to a down arrow once clicked on. Tap the down arrow button to close the Settings Menu.

Selecting the setting options input, you will have access to change brightness, contrast, camera settings, parking line settings, and interface settings. You can close this by selecting the down arrow.

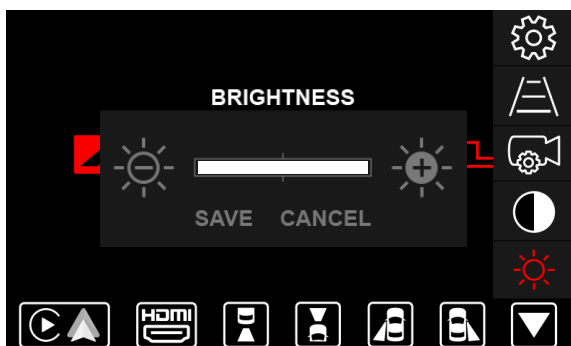

## Brightness

Tap the Brightness button to enter this option.

After selecting brightness, you can adjust the brightness of the interface. The white bar in the middle shows the interface brightness setting. You can lower the brightness of the interface by tapping the minus on the left and increase the interface's brightness by tapping the plus on the right. Save or cancel any changes you have made.

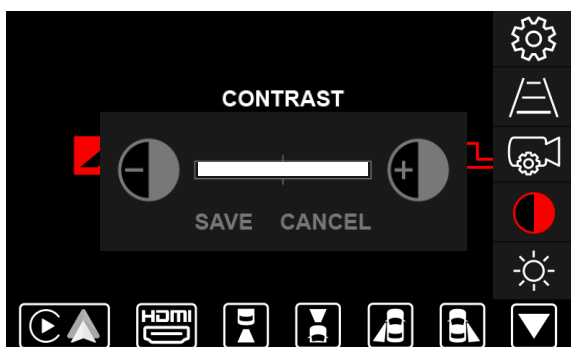

## Contrast

Tap the Contrast button to enter this option.

After selecting contrast, you can adjust the contrast of the interface. The white bar in the middle shows the interface contrast setting. You can lower the contrast of the interface by tapping the minus on the left and increase the interface's contrast by tapping the plus on the right. Save or cancel any changes you have made.

# Interface Menus and Settings



## Camera Settings

Tap the Camera Settings button to enter this option.

### Camera Settings Menu

Tap to select a particular camera input. Tap repeatedly to change the option to what you want for that particular camera input.

**Factory camera:** Select this option if your vehicle is equipped with a factory installed rear view camera.

**Video input:** Select this option if your vehicle is not equipped with a factory rear view camera and you are not planning to add a aftermarket camera or if you wish to use this input as a video input.

**Aftermarket camera:** Select this option if you are installing an aftermarket rear view camera.

**Parking lines:** Select this option if you are installing an aftermarket rear view camera and you wish to add distance lines to the camera image.

**Factory camera:** Select this option if your vehicle is equipped with a factory installed forward facing camera. Do not select this option if your vehicle is equipped with 360 degree parking cameras, 360 degree front parking camera is not considered forward facing camera.

**Video input (Select for most installations):** Select this option if your vehicle is not equipped with a factory forward facing camera and you are not planning to add a aftermarket camera or if you wish to use this input as a video input.

**Aftermarket camera:** Select this option if you are installing an aftermarket forward facing camera.

**Parking lines:** Select this option if you are installing an aftermarket forward facing camera and you wish to add distance lines to the camera image.

INPUTS	FACTORY CAMERA	VIDEO INPUT	AFTERMARKET CAMERA	PARKING LINES
	<input type="radio"/>	<input type="radio"/>	<input type="radio"/>	<input type="radio"/>
	<input type="radio"/>	<input type="radio"/>	<input type="radio"/>	<input type="radio"/>
	<input type="radio"/>	<input type="radio"/>	<input type="radio"/>	<input type="radio"/>
	<input type="radio"/>	<input type="radio"/>	<input type="radio"/>	<input type="radio"/>
				SAVE CANCEL

**Factory camera:** Select this option if your vehicle is equipped with a factory installed right lane watch camera. Do not select this option if your vehicle is equipped with 360 degree parking cameras, 360 degree right parking camera is not considered forward facing camera.

**Video input (Select for most installations):** Select this option if your vehicle is not equipped with a factory right lane watch camera and you are not planning to add a aftermarket camera or if you wish to use this input as a video input.

**Aftermarket camera:** Select this option if you are installing an aftermarket right lane watch camera.

**Parking lines:** Select this option if you are installing an aftermarket right lane watch camera and you wish to add distance lines to the camera image.

**Factory camera:** Select this option if your vehicle is equipped with a factory installed left lane watch camera. Do not select this option if your vehicle is equipped with 360 degree parking cameras, 360 degree front parking camera is not considered forward facing camera.

**Video input (Select for most installations):** Select this option if your vehicle is not equipped with a factory left lane watch camera and you are not planning to add a aftermarket camera or if you wish to use this input as a video input.

**Aftermarket camera:** Select this option if you are installing an aftermarket left lane watch camera.

**Parking lines:** Select this option if you are installing an aftermarket left lane watch camera and you wish to add distance lines to the camera image.

# Interface Menus and Settings

For most installations, there is no need to enter below menus

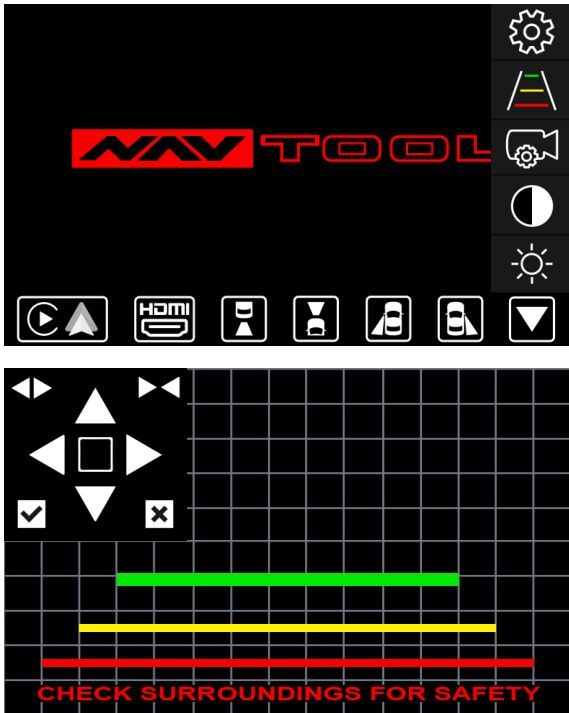

## Parking Line Settings

(These line adjustments are only for aftermarket cameras, they do not affect factory cameras)

Tap the Parking Line Settings button to enter this option.

You can only access this setting when you are on the particular camera input. Select the camera input prior to going into parking line settings.

## Parking Line Settings

After selecting parking line settings, you can adjust the parking lines of the interface. Your interface will display which camera input you chose with gridlines instead of a black background. You can choose which parking line you want to make changes to by selecting the square in the middle. The white circle in the square indicates which parking line you are making changes to.



### Increase Line Width

You can increase your parking line width to a desired size.

### Up

You can move your parking lines up by selecting the up arrow for your selected parking line.

### Decrease Line Width

You can decrease your parking line width to a desired size.

### Left

You can move your parking lines left by selecting the left arrow for your selected parking line.

### Right

You can move your parking lines right by selecting the right arrow for your selected parking line.

### Save

After making changes to your parking line settings, select the check to save your changes.

### Down

You can move your parking lines down by selecting the down arrow for your selected parking line.

### Cancel

After making changes to your parking line settings, select the X to cancel your changes.

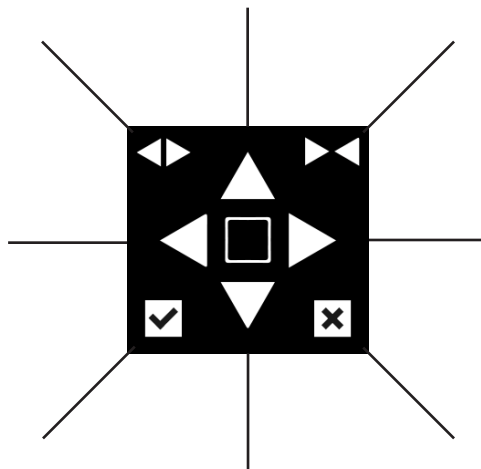

# Interface Menus and Settings



## Interface Settings

Tap the Interface Settings icon to enter this option.

After selecting interface settings, you can adjust miscellaneous settings of the interface. Save or cancel any interface changes.

Set this feature to ON if you want to directly enter into the Apple CarPlay/Android Auto mode when activating the interface, and bypassing the NavTool menu. Do not select this mode if you plan to use HDMI input or if you want to view other video inputs.

Set this feature to OFF if you want to enter NavTool menu upon activation of the interface.

MISCELLANEOUS SETTINGS	ON	OFF
APPLE CARPLAY / ANDROID AUTO (AUTO ON MODE)	<input type="radio"/>	<input type="radio"/>
INTERFACE CHIRP SOUND	<input type="radio"/>	<input type="radio"/>
MANUAL ACTIVATION WIRE AS REVERSE TRIGGER +12V	<input type="radio"/>	<input type="radio"/>
	SAVE	CANCEL

Turn this feature to ON to enable audio feedback from the interface when activating the interface or when smartphone wireless connection is established.

Turn this feature to OFF if audio feedback from the interface is not required.

Turn ON manual activation wire as reverse trigger if your manual tells you to or if done by an installer. (See page 18 for details)

Turn OFF: Most vehicles will have the manual activation wire turned OFF. (See page 18 for details)

# How to Connect Rear Screens to Car With AV Input

Examples of equipment used if connecting or installing additional rear screens



Car Monitor



NavTool Interface



HDMI to AV Adaptor



1 in 2 Out HDMI Splitter



HDMI Sources

# How to Connect Rear Screens to Car With HDMI Input

Examples of equipment used if connecting or installing additional rear screens



Car Monitor



NavTool Interface



Car HDMI Input



1 in 2 Out HDMI Splitter



HDMI Sources



# User Manual

## Setting Radio to Auxiliary

Plug the NavTool supplied AUX Activator (Part # NT-AUX-ACT) into vehicle's 3.5mm AUX jack. See image below.

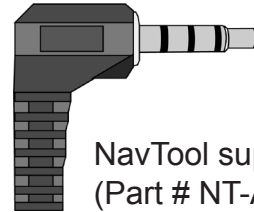
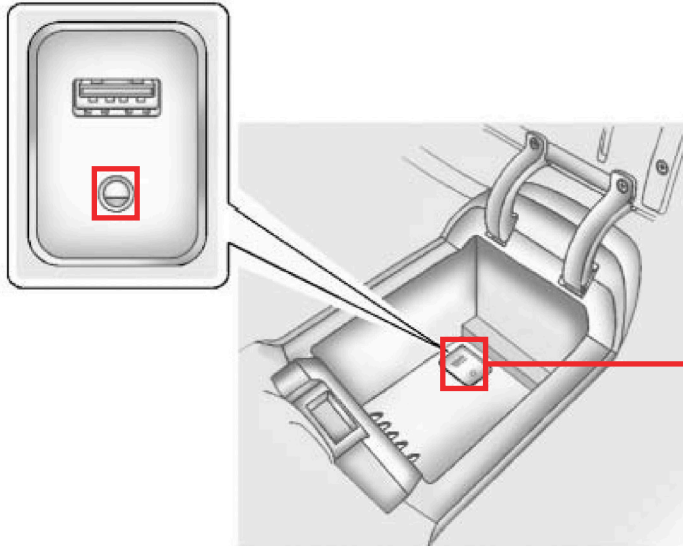

NavTool supplied AUX Activator  
(Part # NT-AUX-ACT)

### AUX Input

Located inside the center console below the arm rest

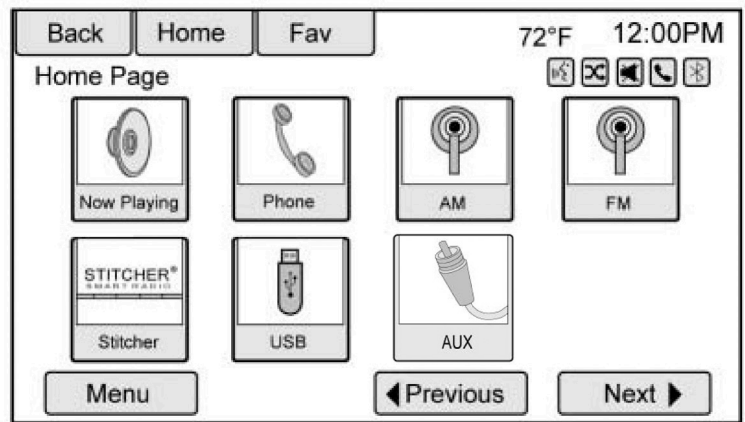
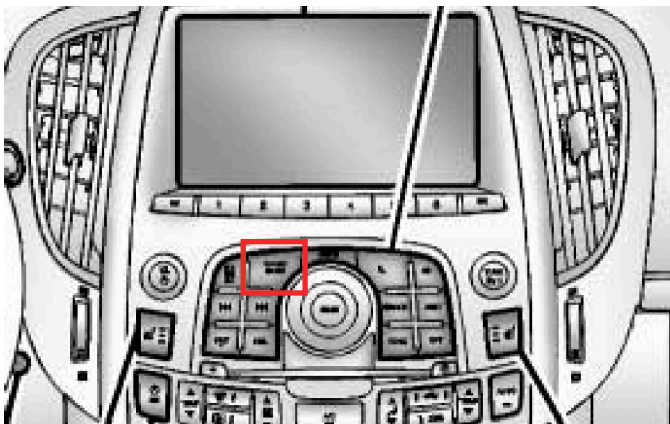

### Set Radio to AUX Audio Input:

- SRCE Button: Press the SRCE button to display the audio screen. Press to switch between AM, FM, or XM, if equipped, Disc, or AUX (Auxiliary). Must set a radio to auxiliary/AUX before activating NavTool to hear audio from car speakers.
- Audio will not play through car speakers if AUX activator jack is not connected or radio is not set to AUX input.

# User Manual

## Quick Operation Guide

Thank you for purchasing NavTool. If you have any questions, please call toll-free at 877-628-8665.

The color/navigation screen will display a factory image when you first start your vehicle.

 **Prior to NavTool installation, if your smartphone is paired to the vehicle bluetooth system for calling, please go into your smartphone bluetooth settings, find your vehicle and do Forget This Device.**

- Set the radio to AUX input to hear the Apple CarPlay/Android Auto audio. Navigation directions, music, and phone calls from the NavTool Apple CarPlay/Android Auto interface will play via AUX input of the radio. See Page 1 for details.
- Press and hold one of the four corners with your thumb for 3 seconds to activate the interface. The preferred corner is the top right. (see Fig.1) You should hear a chirp, and after that, the interface will start, and the NavTool menu will appear on the screen. After activating the interface, the NavTool screen will show. (see Fig.2)



Fig. 1



Fig. 2

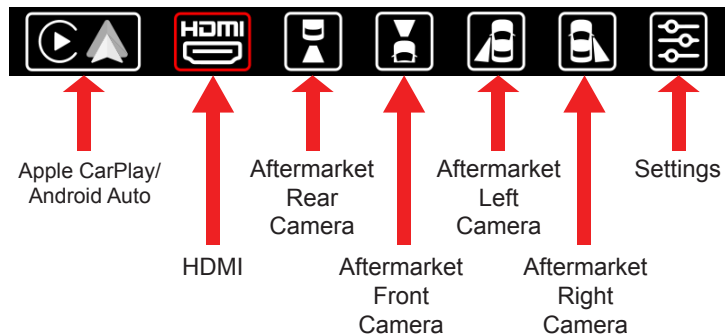

**How to exit video inputs:** To leave HDMI or any camera inputs, tap anywhere on the touch screen to bring up the bottom menu bar.

**Aftermarket Camera Operation:** The factory rearview camera will continue to work in reverse. If you installed a forward-facing camera, you could manually select it in the menu, or it will automatically display up to 10 miles per hour on the screen. This automation will happen when you put the car into drive after reverse gear. Aftermarket left and right lane watch cameras will work with respective turn signals while driving or can be selected manually via the menu.

**How to Return to Factory Screen:** Press and hold one of the four corners of the touch screen for 3 seconds to turn off NavTool interface. Press and hold the corner of the touch screen for a few seconds until the bottom menu appears on the screen, release the finger and hold the corner of the screen again to return to the factory menu.



# User Manual

## Interface Settings



### Settings

- Tap the settings menu button
- This will open a menu that will let you change different settings on the interface.



### Interface Settings

- Tap the settings gear icon.
- This will let you change different interface settings.

Set this feature to ON if you want to directly enter into the Apple CarPlay/Android Auto mode when activating the interface, and bypassing the NavTool menu. Do not select this mode if you plan to use HDMI input or if you want to view other video inputs.

Set this feature to OFF if you want to enter NavTool menu upon activation of the interface.

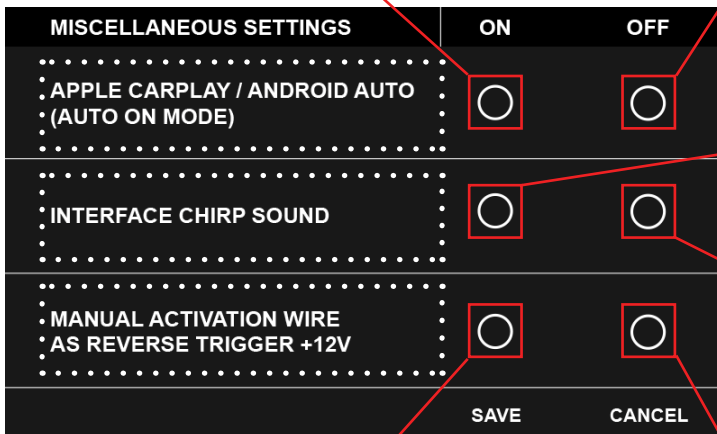

Turn this feature to ON to enable audio feedback from the interface when activating the interface or when smartphone wireless connection is established.

Turn this feature to OFF if audio feedback from the interface is not required.

Turn ON manual activation wire as reverse trigger if your manual tells you to or if done by an installer. Do not change if installer has set this feature to ON.

Turn OFF: Most vehicles will have manual activation wire turned off. Do not change if installer has set this feature to OFF.

- Tap the text of the setting you want to change. This will turn the setting ON or OFF.
- SAVE or CANCEL your changes.



### Parking Line Settings

Typically adjusted by installer.



### Camera Settings

Typically adjusted by installer.

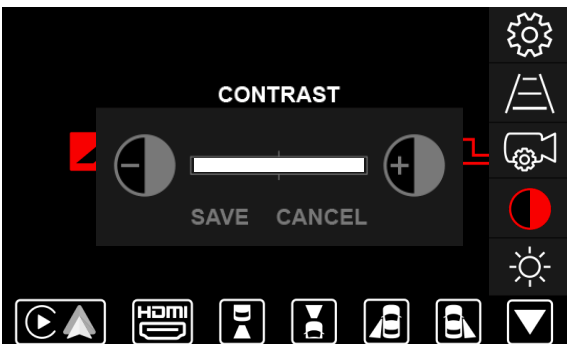

### Contrast

Tap the Contrast button to enter this option.

After selecting contrast, you can adjust the contrast of the interface. The white bar in the middle shows the interface contrast setting. You can lower the contrast of the interface by tapping the minus on the left and increase the interface's contrast by tapping the plus on the right. Save or cancel any changes you have made.

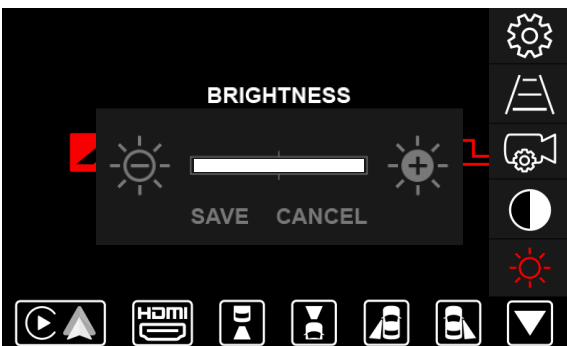

### Brightness

Tap the Brightness button to enter this option.

After selecting brightness, you can adjust the brightness of the interface. The white bar in the middle shows the interface brightness setting. You can lower the brightness of the interface by tapping the minus on the left and increase the interface's brightness by tapping the plus on the right. Save or cancel any changes you have made.