

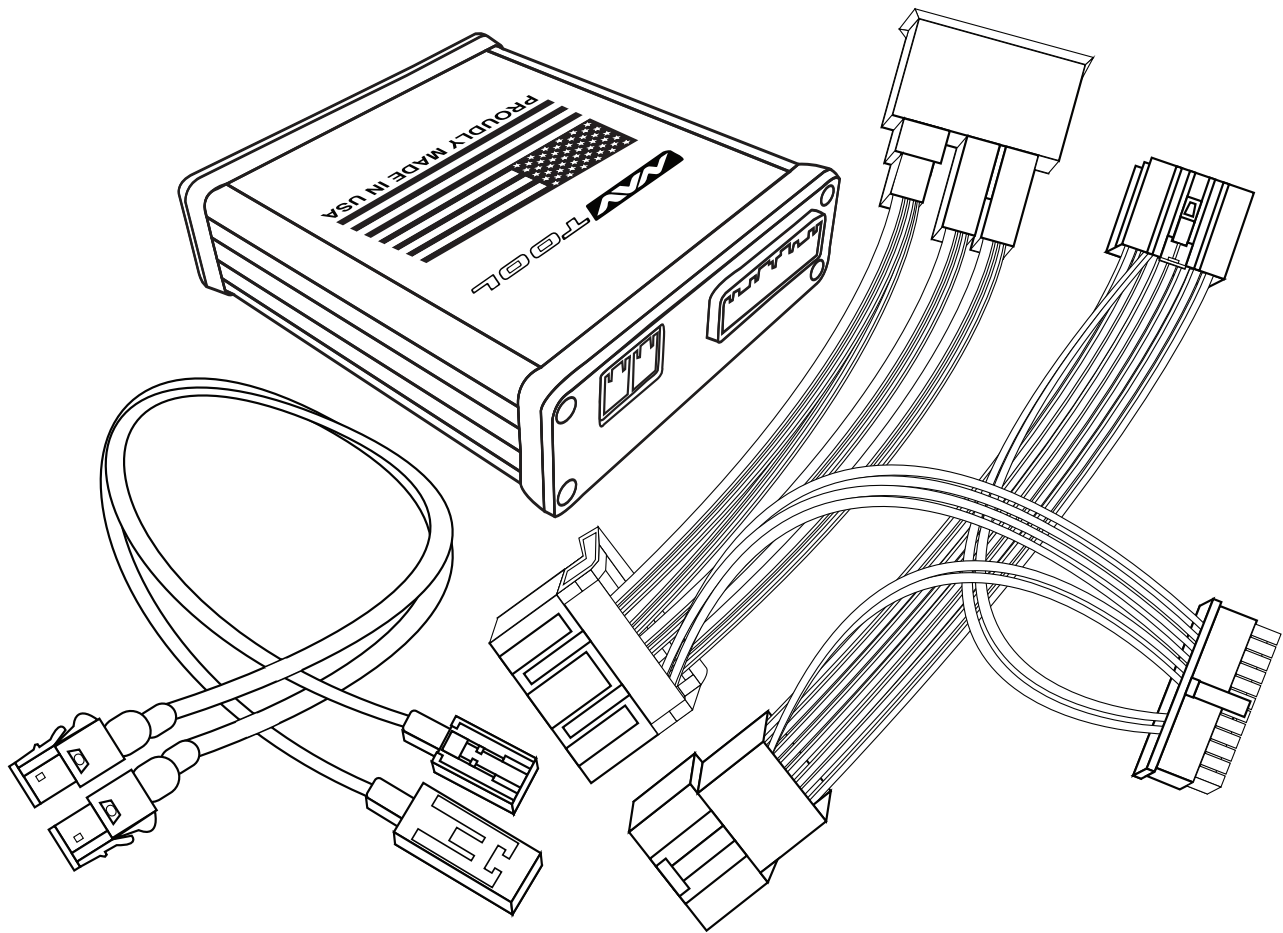

# Installation Manual

## Buick Cascada 2016-2020



### Interface with Apple CarPlay and Android Auto

### Part #: NAVTOOL6.0-LG1-NBT

*NOTICE: Navtool recommends having this installation performed by a certified technician.  
Logos and trademarks used here in are the properties of their respective owners.*



**Buick Cascada 2016-2020**

# WELCOME

## IMPORTANT WARNING

This product includes instructions for installation, which must be carefully followed. The instructions are worded in such a manner to assume that the installer is capable of completing these types of electronic installations. Suppose you are unclear about what you are instructed to do or believe you do not understand the instructions to complete the installation properly and safely. In that case, you should consult a technician who has this knowledge and understanding. Failure to follow these instructions carefully and install the interface as described could cause harm to the vehicle or safety systems on the vehicle. Interference with specific safety systems could cause damage to persons as well.



## NEED HELP?



Open the camera app on your smartphone and point your rear camera at the QR-Code to scan it. Finally, tap the pop up banner to open support website.

# Table of Contents

## Installation Instructions

<a href="#">Precautions</a>	3
<a href="#">What's In The Box</a>	4
<a href="#">Interface Connectors Description</a>	5
<a href="#">Universal Harness Description</a>	6
<a href="#">Quick Connection Guide</a>	7-8
<a href="#">Installation Instructions</a>	9-16
<a href="#">Testing and Settings</a>	17-21

## Extra Details

<a href="#">Vehicle Reassembly Checklist</a>	22
<a href="#">Apple CarPlay/Android Auto Menus</a>	23-35
<a href="#">Video Interface Menus</a>	36-41
<a href="#">Connect Rear Screens With AV Input</a>	42
<a href="#">Connect Rear Screens With HDMI Input</a>	43

## User Manual

<a href="#">User Manual</a>	End Pages 1-7
-----------------------------	---------------

**Print End Pages 1-7  
and give them to the customer**

# Precautions

---

## PLEASE READ BEFORE YOU START THE INSTALLATION

- Please study these instructions carefully before installing NavTool interface.
- Many new vehicles use low-voltage or data-bus systems that can be damaged by test lights and logic probes. Test all circuits with a digital multi-meter before making connections.
- Do not disconnect the battery if the vehicle has an anti-theft-coded radio, unless you have the radio code.
- If installing an external push button switch, check with the customer about where to install the switch.
- To avoid accidental battery drainage turn off the interior lights or remove the dome light fuse.
- Roll down a window to avoid being locked out of the car.
- Use of this product in a manner different to its intended way of operation may result in property damage, personal injury, or death.
- Set Parking brake.
- Remove the negative battery cable.
- Protect fenders before starting.
- Using protective blankets to cover front seats, interior of the vehicle and center console.
- Always install a fuse 6-12 inches away from NavTool interface, 5 amp fuse should be used.
- Always secure NavTool interface with Velcro or double side tape to prevent rattling of the interface.
- When securing NavTool interface make sure that panels can be closed back easily.
- Use electrical tape on all you connections and splices, do not leave any exposed connections.
- Route all wires along factory harnesses, try not to drill or make any unnecessary holes.
- Make sure you are not connecting to any data wires; always check your connections with a multi-meter.
- Always use help of a professional installer to prevent any damage to the vehicle or NavTool interface.

# What's In The Box?

NavTool Interface  
(Part # NAVTOOL6.0-LG1-NBT)

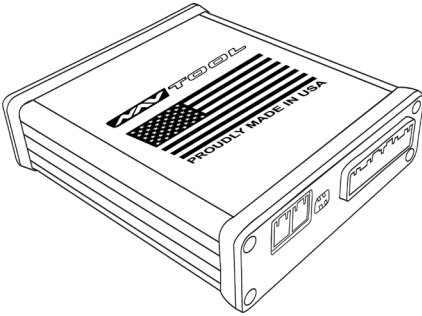

NavTool LVDS Cables  
(Part # NT-GMBLU-LVDS)

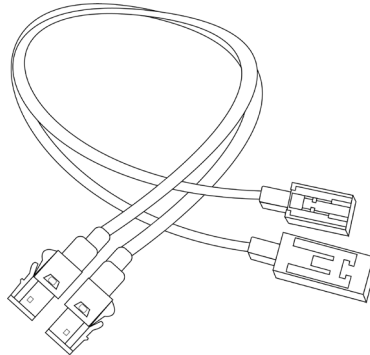

USB Configuration Cable  
(Part # NT-USB-CNG)

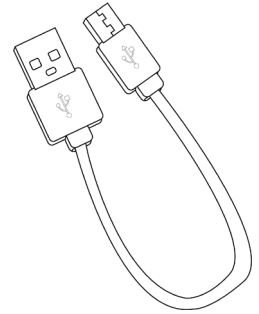

NavTool Interface Harness  
(Part # NT-WHNT6)

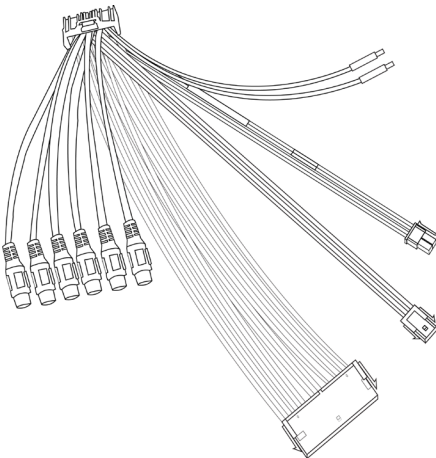

NavTool Vehicle Specific  
Plug and Play Harness  
(Part # NT-GMQUAD-BLU)

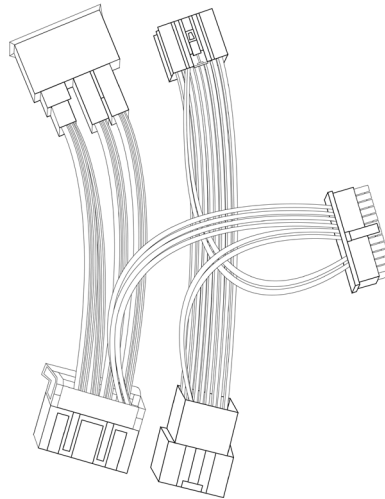

NavTool AUX Activator  
(Part # NT-AUX-ACT)

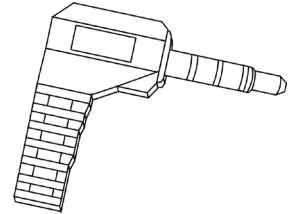

# Interface Connectors Description

## NavTool Interface (Part # NAVTOOL6.0-LG1-NBT)

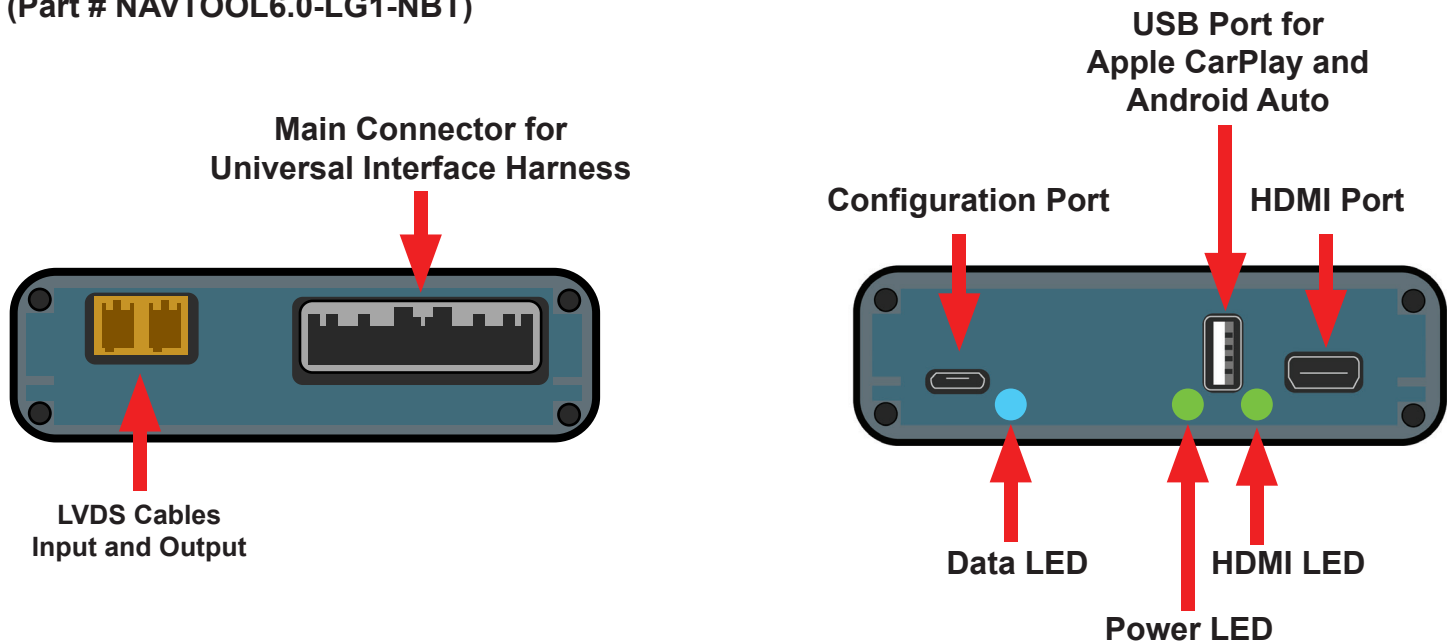

**Main Connector for Universal Interface Harness-** This port is dedicated for a connection of a universal wiring harness

**LVDS Cables Input and Output-** This port is dedicated for the LVDS cables.

**Configuration Port-** This USB port is dedicated for the interface configuration only.

**Data LED-** Normal operation of the interface must have blue LED blinking. If the blue LED is not blinking, the interface is not receiving data from the vehicle. If the blue LED is not blinking, the interface will not operate properly.

**Power LED-** Normal operation of the interface must have a green LED ON. If the green LED is not ON, the interface is not receiving power. If the green LED is not ON, the interface will not work, and your vehicle radio may also stay OFF.

**HDMI LED-** Normal operation of the interface must have a green LED ON. If the green LED is not ON, the interface HDMI is not receiving power. If the green LED is not ON, the interface HDMI port will not work.

**USB Port for Apple CarPlay and Android Auto-** This USB port is for hard-wire connection of a smartphone if you want your iPhone or Android hard-wired to the interface instead of a wireless connection. This USB port also provides charging for your smartphone. This connection is not required if you plan to use Apple CarPlay and Android Auto via the wireless connection. Do not use this USB port to power up HDMI streaming devices such as Roku, FireStick, Chromecast, or similar devices.

**HDMI Port-** HDMI port is dedicated for connecting video sources such as iPhone mirroring, Android Mirroring, Apple TV, Roku, FireStick, Chromecast, PlayStation, Xbox, or similar devices.

# Universal Harness Description

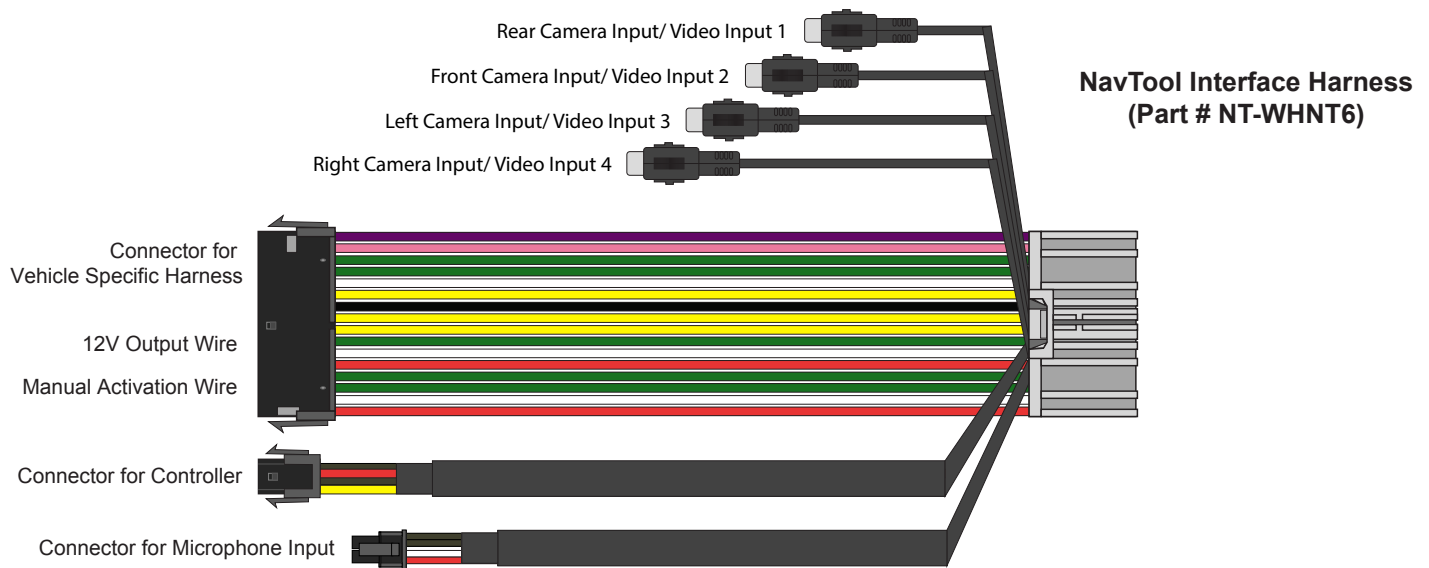

**Rear Camera Input /Video Input 1-** This input is dedicated for an aftermarket rearview camera or a video source with an RCA video output. Your vehicle factory camera will continue to work as before without any changes.

**Front Camera Input /Video Input 2-** This input is dedicated for an aftermarket front view camera or a video source with an RCA video output. Your vehicle factory camera will continue to work as before without any changes.

**Left Camera Input / Video Input 3-** This input is dedicated for an aftermarket left view camera or a video source with an RCA video output. Your vehicle factory camera will continue to work as before without any changes.

**Right Camera Input / Video Input 4-** This input is dedicated for an aftermarket right view camera or a video source with an RCA video output. Your vehicle factory camera will continue to work as before without any changes.

**Connector for Vehicle Specific Harness-** This connection is dedicated for connecting vehicle specific plug and play wiring harness.

**Connector to Controller-** Not Used

**Connector for Microphone Input-** This connection is dedicated for connecting a built-in vehicle microphone. See the quick connection guide on page 7 of this manual.

**+12V Manual Activation Input-** This connection is used only if the factory rearview camera is not operating correctly in reverse. In that case, this wire must be connected to the vehicle's reverse +12V output. (Change setting "Manual Activation Wire as +12V Reverse Input" See page 41)

**+12V Output-** 500 mA output can be used to drive a relay. This output provides +12V at all times when the vehicle is running.

# Quick Connection Guide

See Page 8

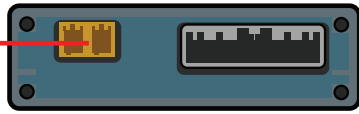

NavTool Interface  
(Part # NAVTOOL6.0-LG1-NBT)

Click



NavTool Supplied Harness  
(Part # NT-WHNT6)

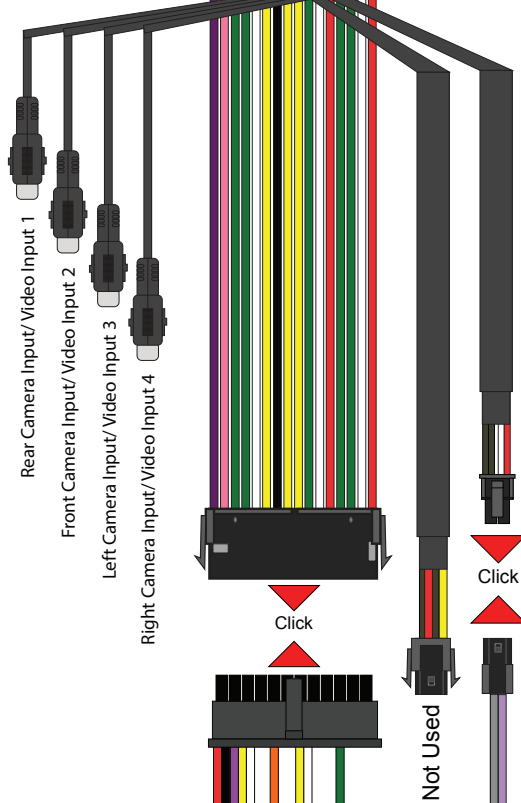

Click

Click

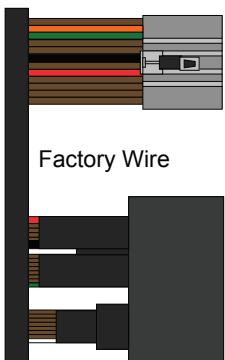

Factory Wire

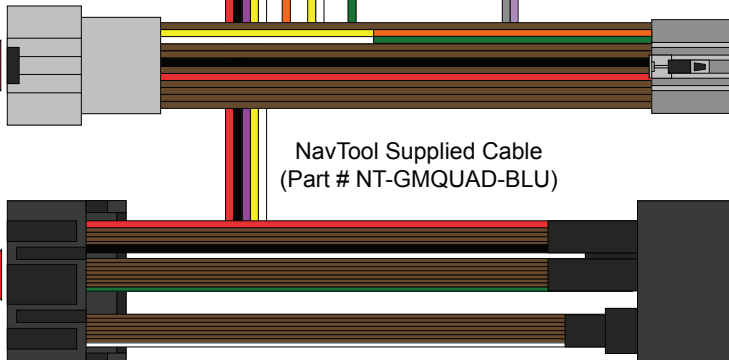

NavTool Supplied Cable  
(Part # NT-GMQUAD-BLU)

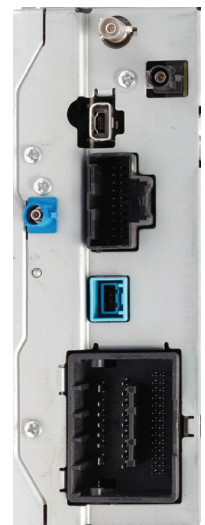

Back of Car Radio

Click

Click

Click

Click

# Quick Connection Guide

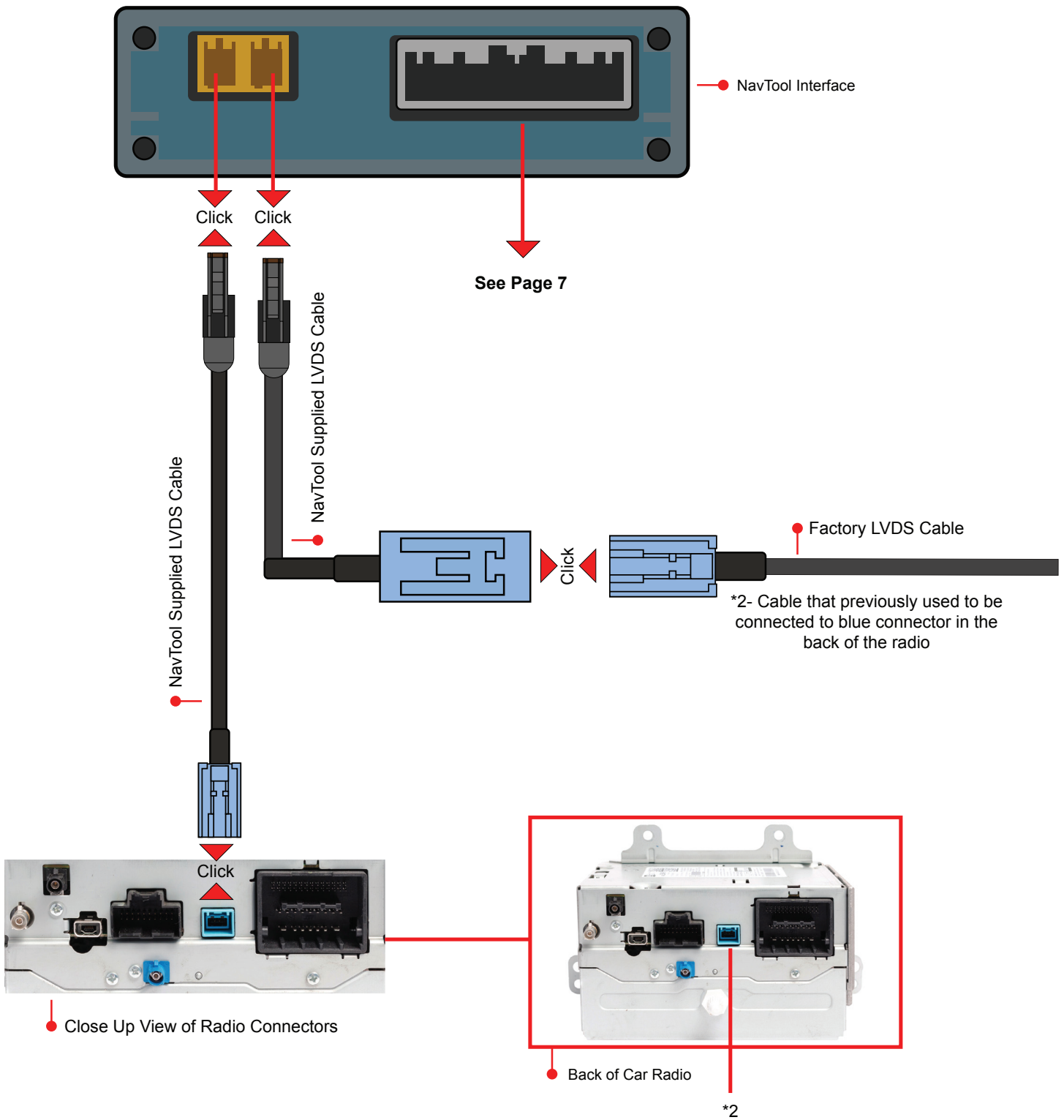



# Installation Instructions

## STEP 1

**NO APPLICATION OR SOFTWARE DOWNLOAD IS REQUIRED TO CONFIGURE THE INTERFACE.**

To configure the interface, you must use Windows, Mac, or Google computer.

Windows computers must use the latest version of Google Chrome or Microsoft Edge browser.

Mac computers must use the latest version of the Google Chrome browser.

Google computers must use the latest version of the Google Chrome browser.

**TO CONFIGURE THE INTERFACE, GO TO [HTTPS://CONFIG.NAVTOOL.COM](https://config.navtool.com)**

Connect the interface to the computer using supplied USB Configuration Cable (Part # NT-USB-CNG)

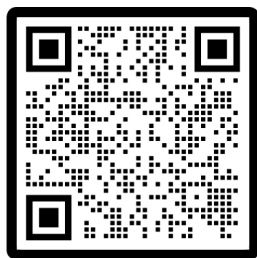
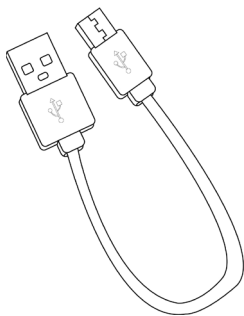

SCAN ME

To see a video of the configuration process  
Scan QR-Code or go to  
[https://youtu.be/iES\\_rW240X0](https://youtu.be/iES_rW240X0)

## STEP 2

**Remove Vehicle Navigation Radio or Color Screen**

**List of Required Tools:**

1. Plastic Panel Removal Tool- Example of a removal tool is shown below. Any similar removal tool will do the job. It does not need to be the same as the picture below.
2. 7 mm Socket- Example of a 7 mm socket tool is shown below. Any similar tool will do the job. It does not need to be the same as the picture below.



# Installation Instructions

## STEP 2 Continued

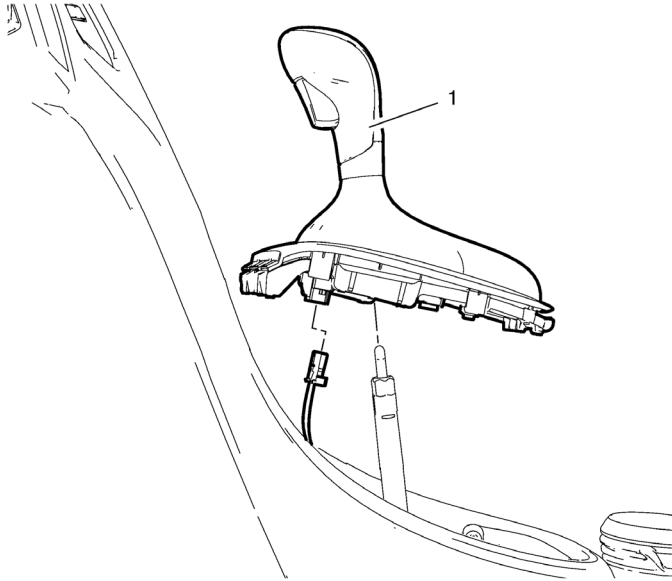

### Step 1:

**Preliminary Procedure:** Set the parking brake and, with the engine OFF, shift transmission to neutral.

- Unclip the transmission control indicator opening cover from the central console.
- Disconnect the range indicator connector.
- Remove the transmission control lever knob from the transmission control. Pulling upward with a twisting motion will aid in disengaging the retainer.

**Note:** The transmission control lever knob is only available along with the control lever boot and the control indicator opening cover as an assembly.

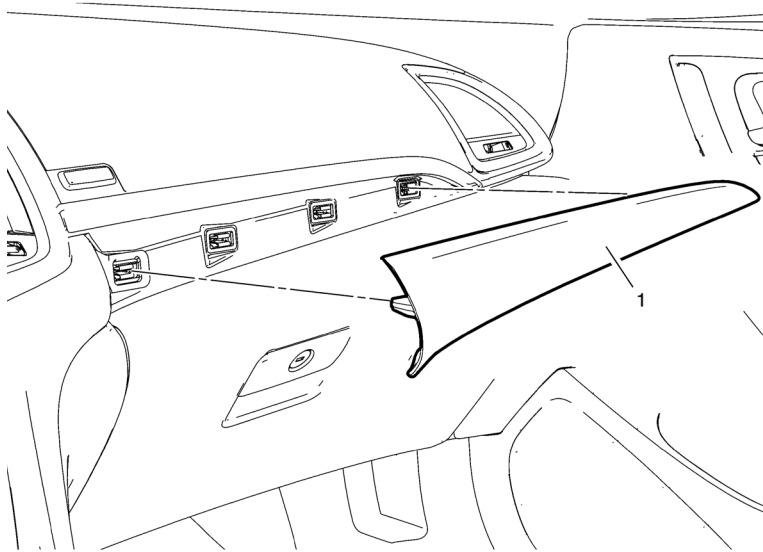

### Step 2:

- Use a flat-bladed plastic trim tool to aid in the removal of the trim plate applique.

# Installation Instructions

## STEP 2 Continued

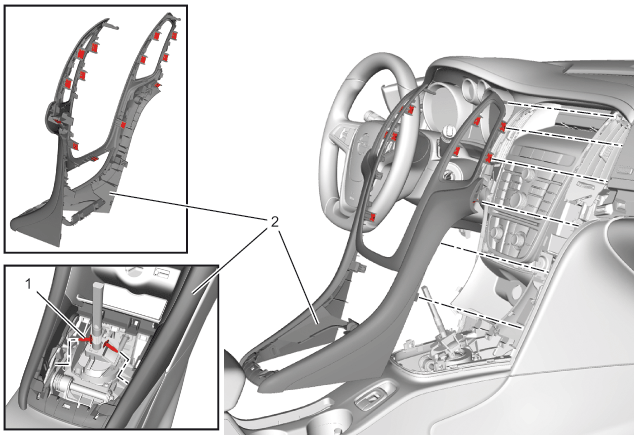

### Step 3:

- Instrument Panel Center Trim Panel Fastener [2x]
- Use a flat bladed plastic tool to remove.

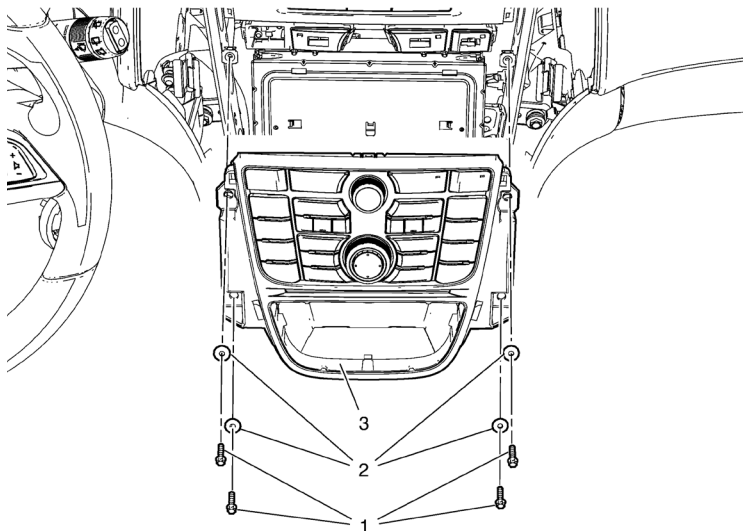

### Step 4:

- Radio Control Bolts (Qty: 4)
- Radio Control Washer (Qty: 4)
- Disconnect the electrical connector.

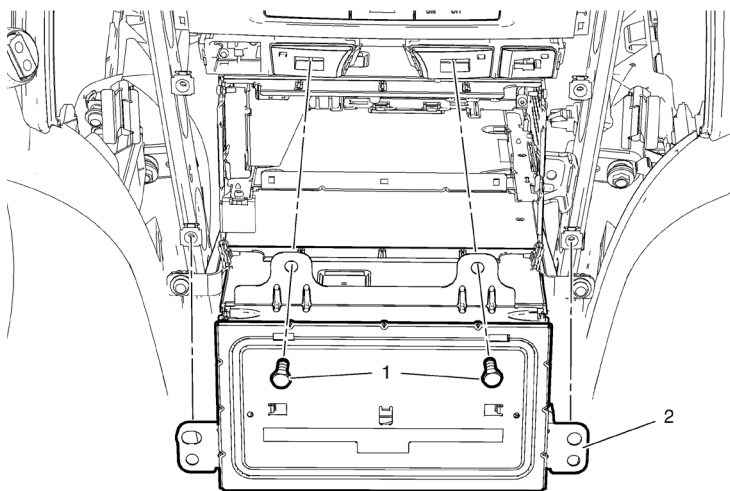

### Step 5:

- Radio Bolt (Qty: 2)
- Disconnect electrical components.

# Installation Instructions

## STEP 3

**Step 1:** Connect supplied plug and play harness (Part # NT-GMQUAD-BLU) to the back of the radio.

**Step 2:** Connect factory connectors into the supplied vehicle specific plug and play harness.

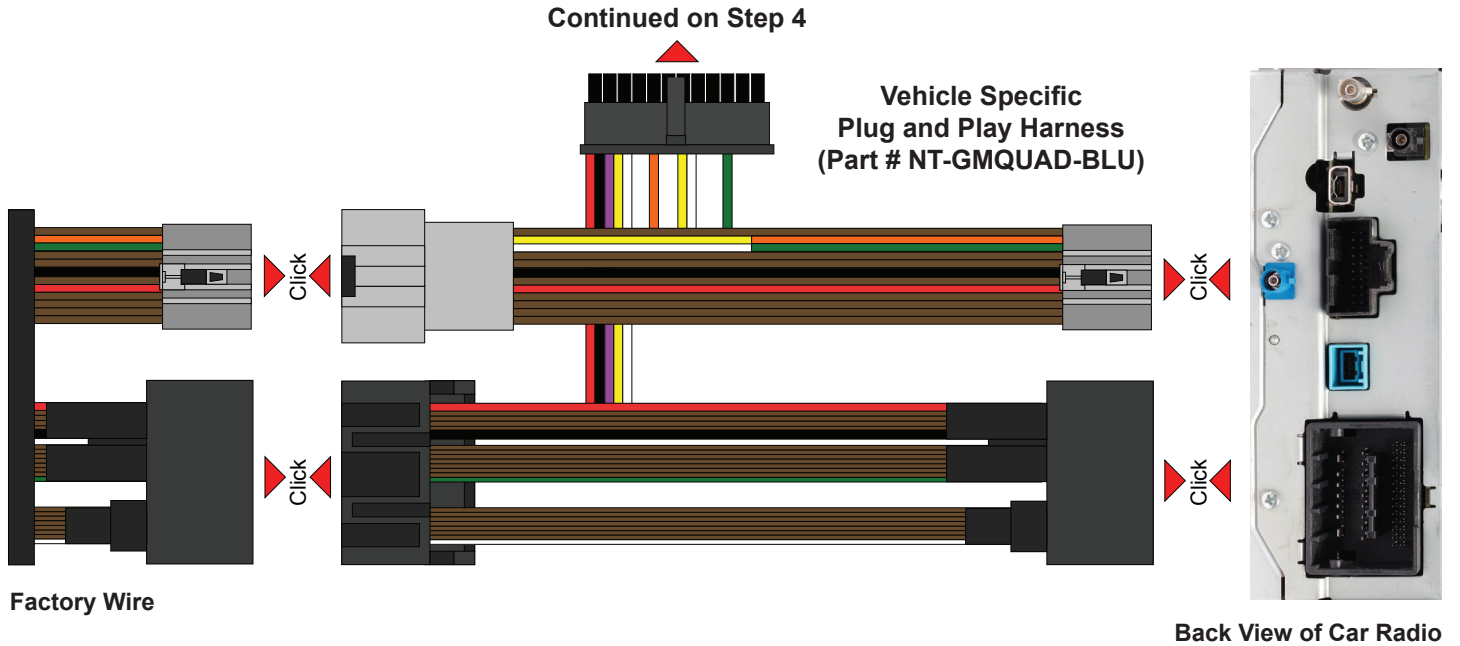

(For complete image, see Quick Connection Guide on page 7)

**Step 2:** Reconnect previously removed radio connectors into the back of the radio.

## STEP 4

Connect supplied universal wiring harness (Part # NT-WHNT6) into plug and play harness (Part # NT-GMQUAD-BLU).

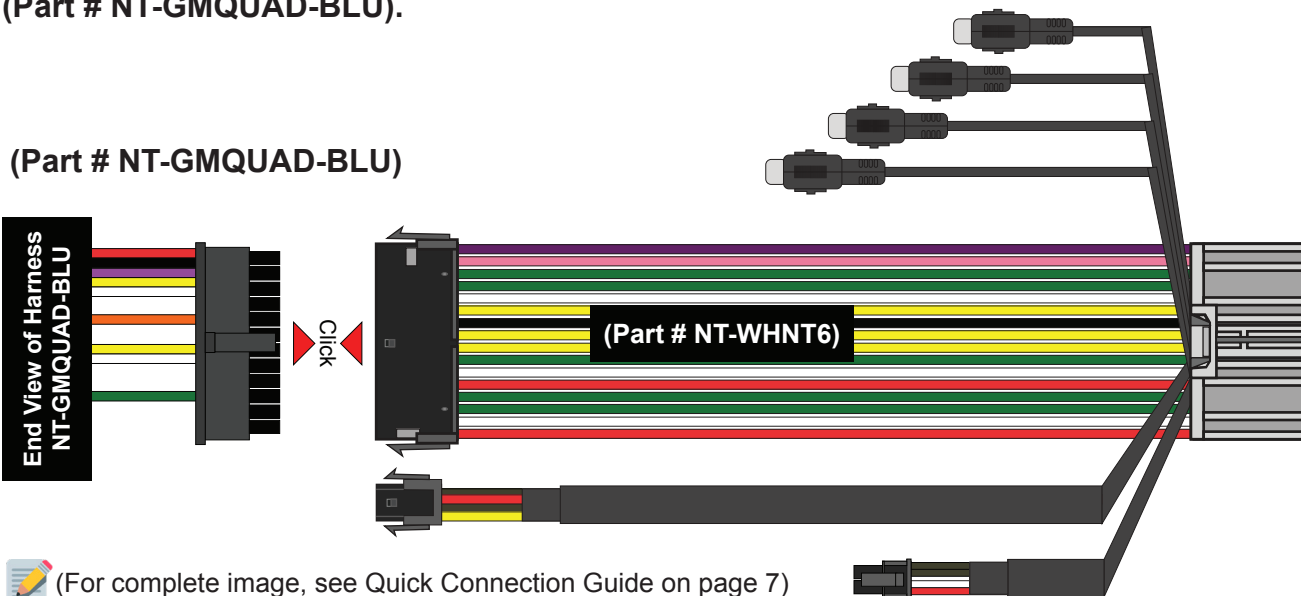

(For complete image, see Quick Connection Guide on page 7)

# Installation Instructions

## STEP 5

**Step 1:** Connect the 4 pin plug from the vehicle specific supplied harness (Part # NT-GMQUAD-BLU) to the 4 pin microphone input connector on the NavTool Interface Harness (Part # NT-WHNT6).

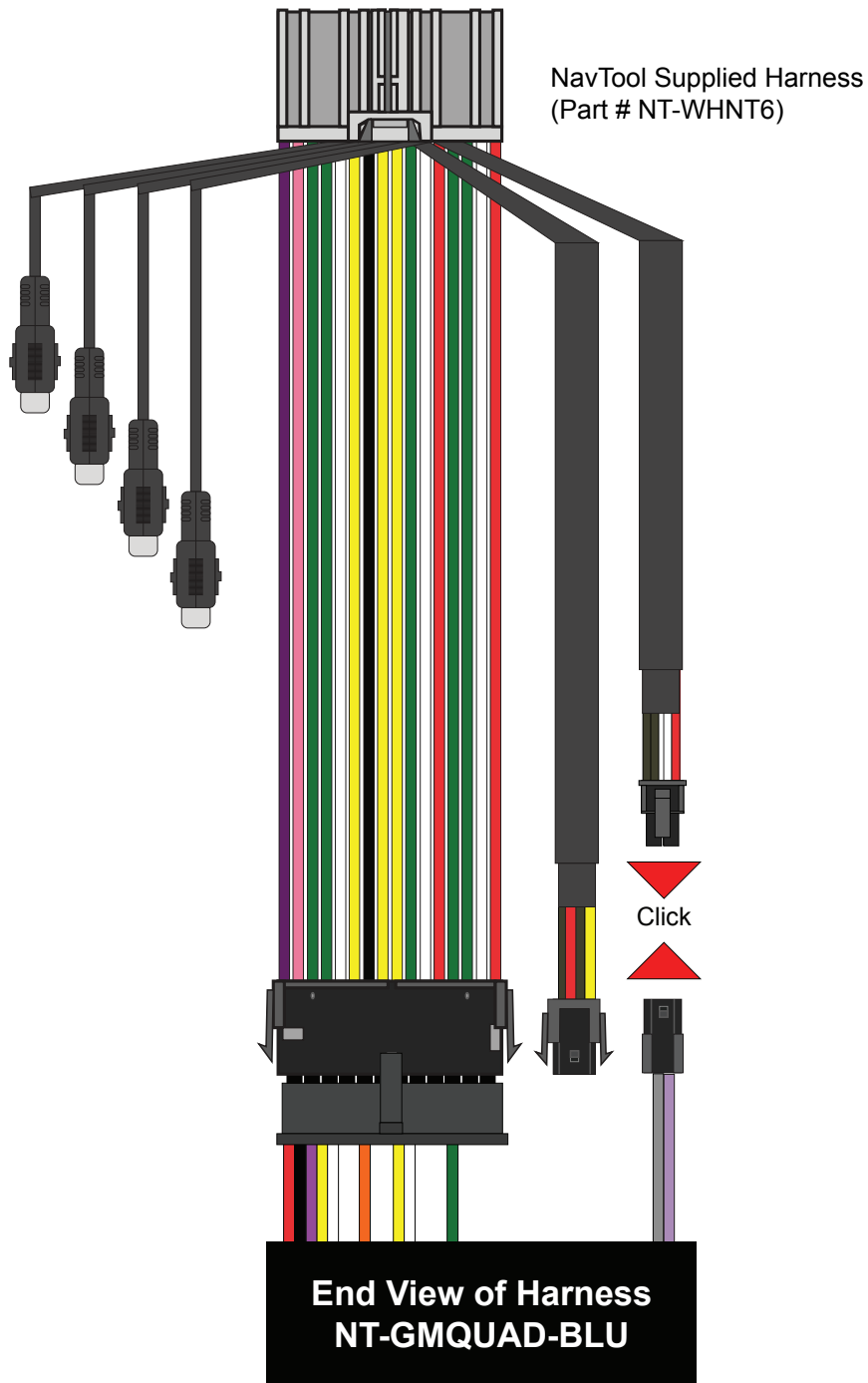

# Installation Instructions

## STEP 6

**Step 1:** Connect factory LVDS cable into the NavTool supplied LVDS cable.

**Step 2:** Connect NavTool supplied LVDS cable into the brown port shown in the image below.

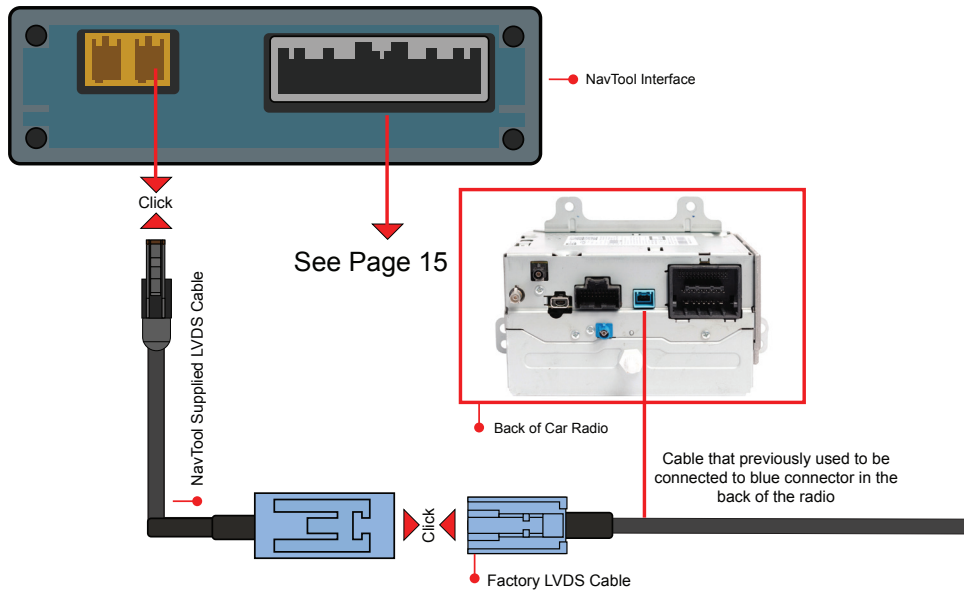

## STEP 7

**Step 1:** Connect NavTool supplied LVDS cable into the blue port on the back of the radio.

**Step 2:** Connect NavTool supplied LVDS cable into the brown port shown in the image below.

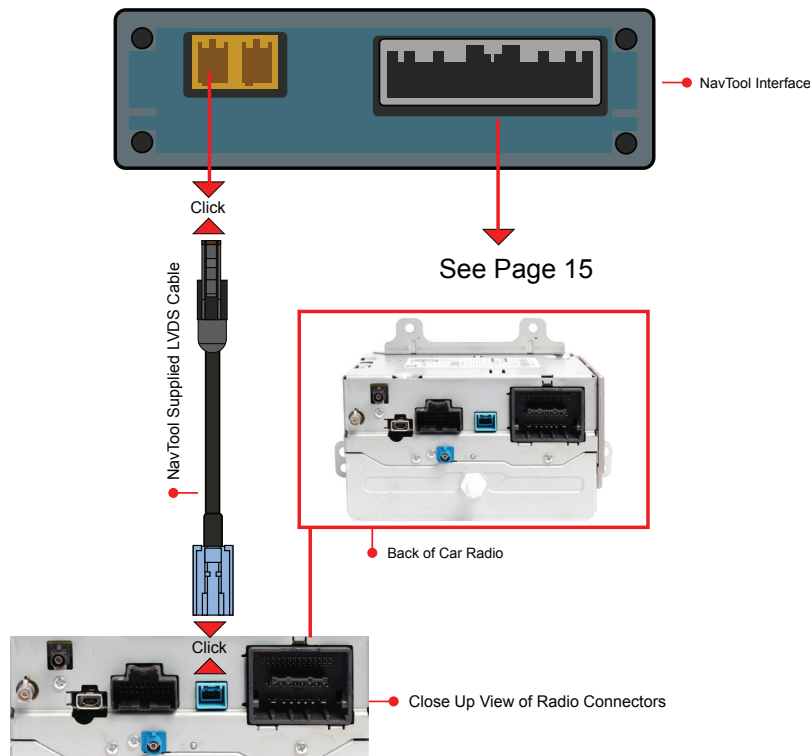

# Installation Instructions

## STEP 8

Plug the universal wiring harness (Part # NT-WHNT6) into in main interface (Part # NAVTOOL6.0-LG1-NBT) into. See quick connection guide on page 7.

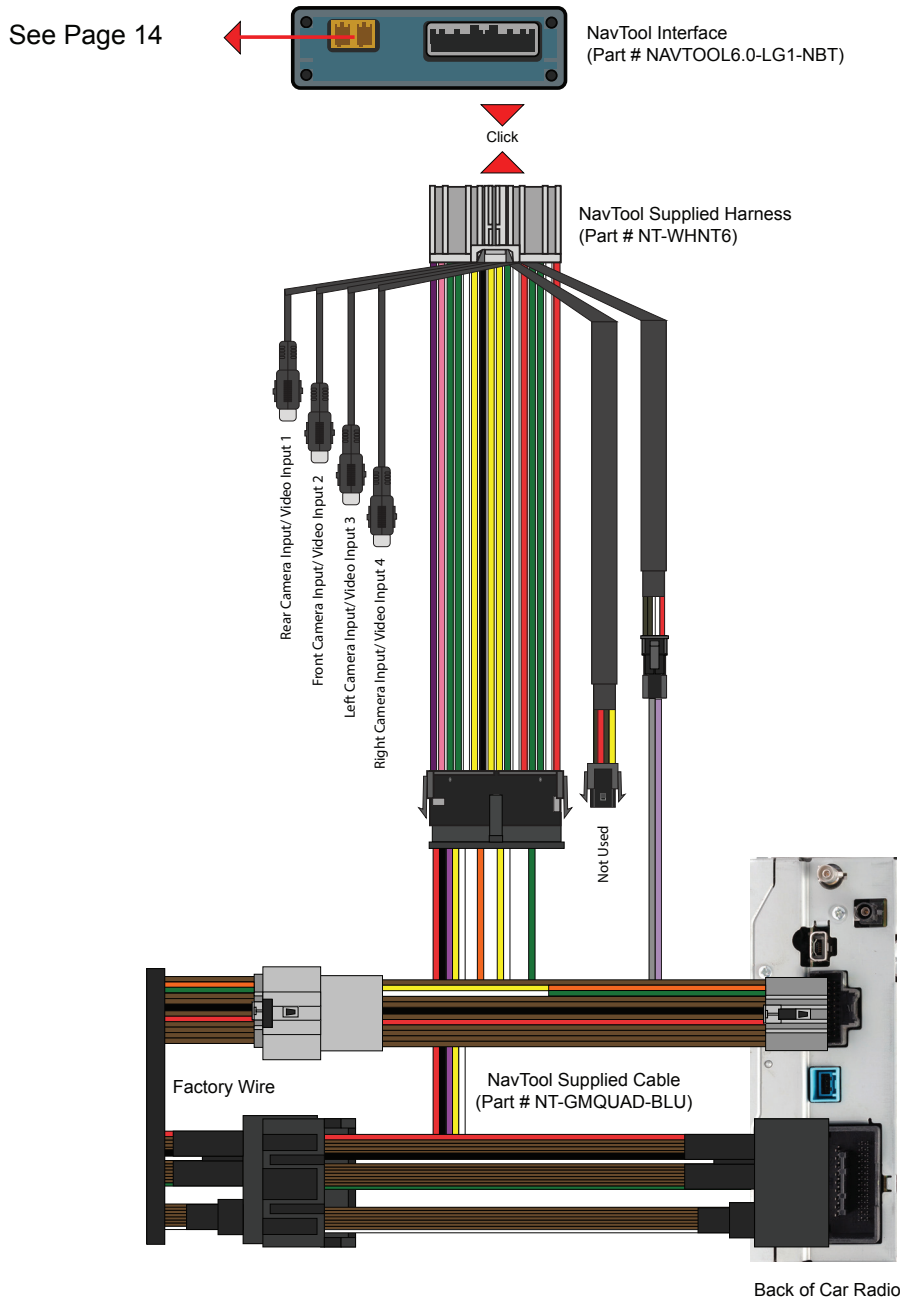

- The NavTool interface installation is now complete.
- Do not reassemble the vehicle until testing is fully complete. Only after you have tested that everything is working can you reassemble the car.
- If you are adding side or front cameras, install them and plug them into the appropriate camera RCAs.
- If you are installing any HDMI or streaming devices, connect it to the HDMI port of the NavTool.

# Installation Instructions

## STEP 9

Plug the NavTool supplied AUX Activator (Part # NT-AUX-ACT) into vehicle's 3.5mm AUX jack. See number 13 on the drawing below.

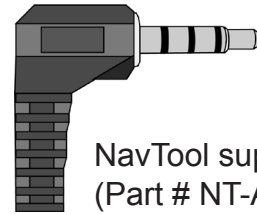
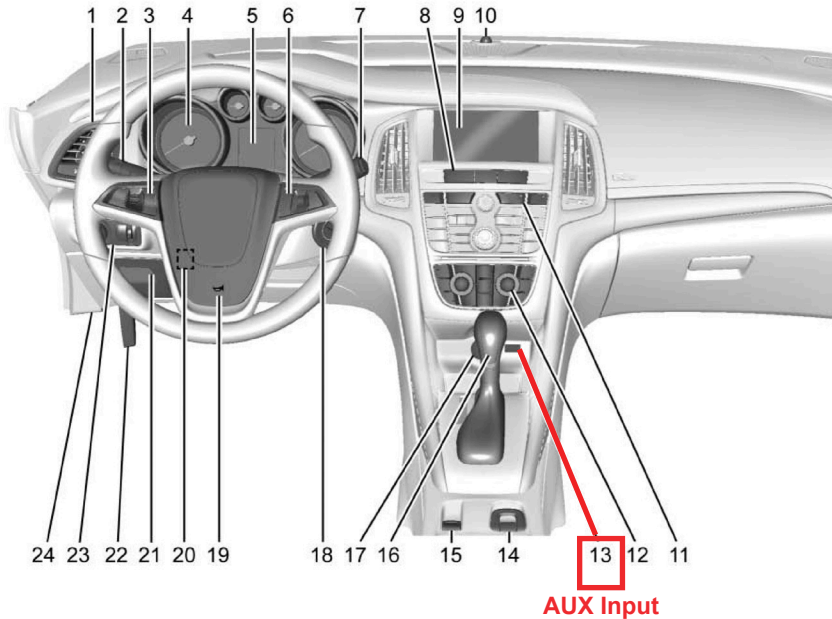

NavTool supplied AUX Activator  
(Part # NT-AUX-ACT)

## STEP 10

After the interface is installed and you activate the NavTool, if your screen is blinking or you see a NavTool image for a second and it goes to a black screen, you must cut a wire on the harness.

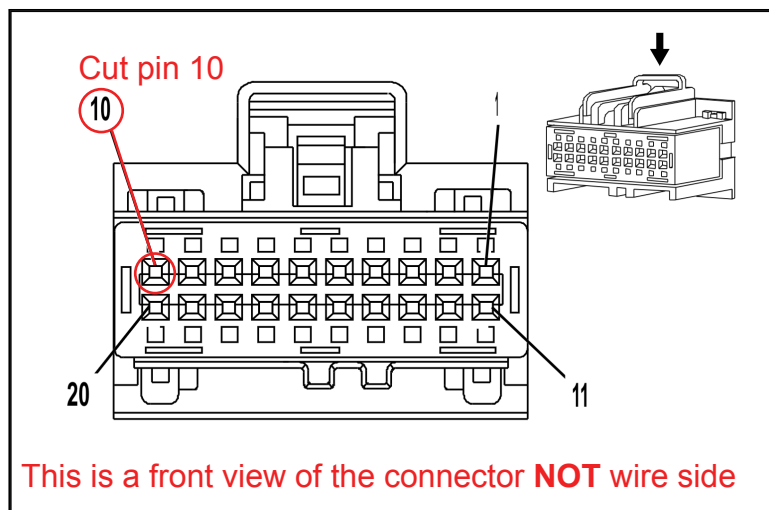



# Testing and Settings

## STEP 1

- Start the car, observe NavTool LED lights should be one blinking blue and two steady lit green LED lights.

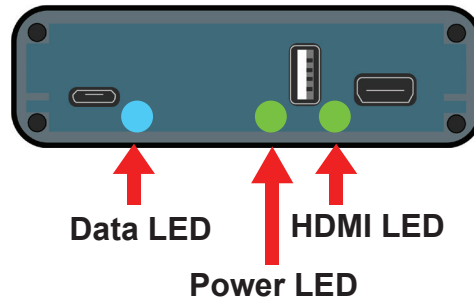

- At this time, your car radio should boot up into its initial state, and the radio should be working. Please check that the radio operates appropriately. All radio functions are working, including CD, Satellite Radio, AM/FM radio, audio plays from car speakers, and all other radio features.

## STEP 2

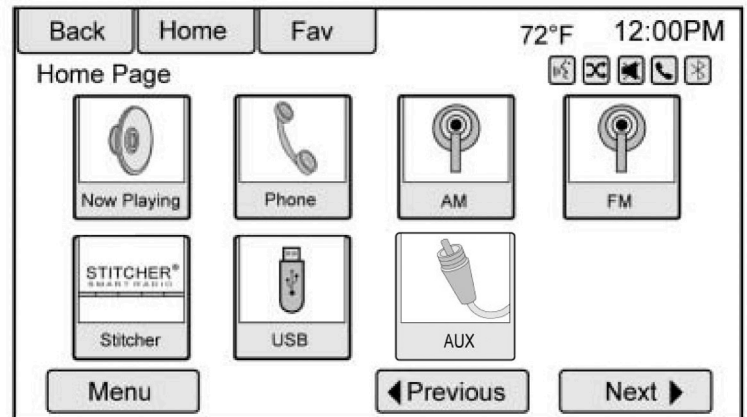
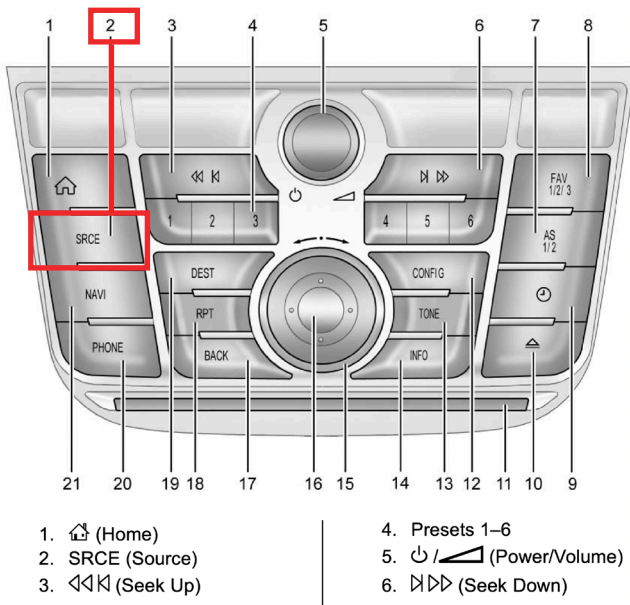

### Set Radio to AUX Audio Input:

- SRCE Button: Press the SRCE button to display the audio screen. Press to switch between AM, FM, or XM, if equipped, Disc, or AUX (Auxiliary). Must set a radio to auxiliary/AUX before activating NavTool to hear audio from car speakers.
- Audio will not play through car speakers if AUX activator jack is not connected or radio is not set to AUX input.

# Testing and Settings

## STEP 3

- Press and hold one of the four corners with your thumb for 3 seconds to activate the interface. The preferred corner is the top right. You should hear a chirp, and after that, the interface will start, and the NavTool menu will appear on the screen. After activating the interface, the NavTool screen will show (see Fig.2)

 After the interface is installed and you activate the NavTool, if your screen is blinking or you see a NavTool image for a second and it goes to a black screen, you must cut a wire on the harness. (See Page 16)



Fig. 1

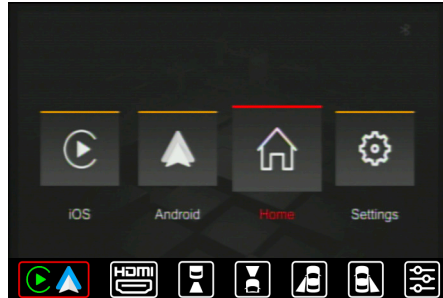
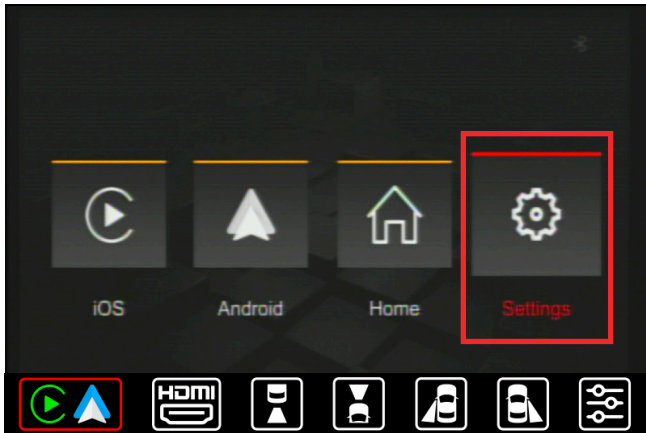

Fig. 2

## STEP 4

- Turn OFF factory microphone feature in the Apple CarPlay/Android Auto settings.

### Step 1:



Touch the Apple CarPlay/Android Auto to enter the Apple CarPlay/Android Auto mode, then click on settings.

### Step 2:

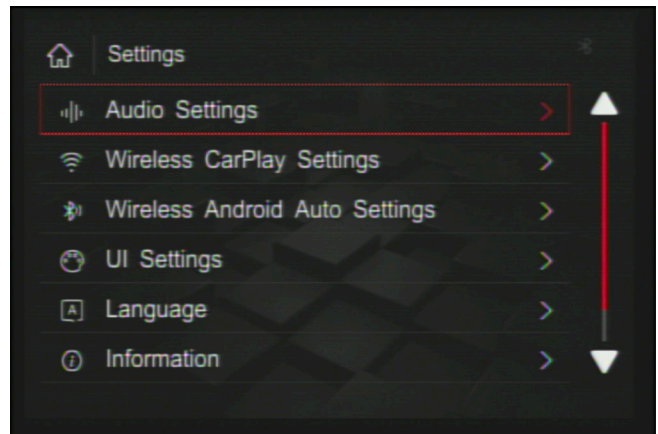

You should now see the settings screen above. Touch the audio settings tab.

# Testing and Settings

## STEP 4 Continued

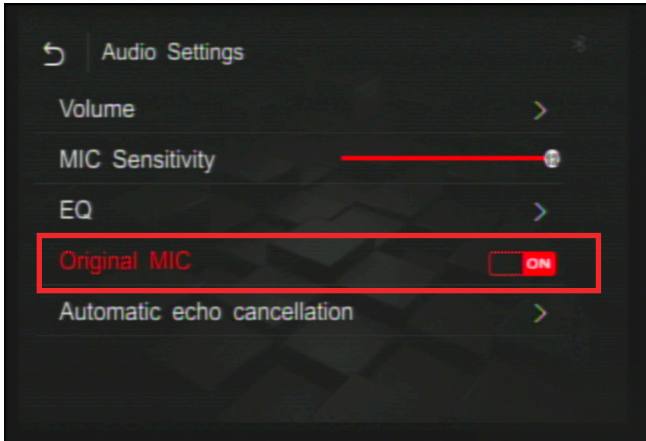

### Audio Settings- Original MIC ON

- Set Original MIC to ON
- Press the back arrow on the top left to return to the main menu

## STEP 5

Adjust camera inputs if you haven't done so already during the initial configuration of the interface.

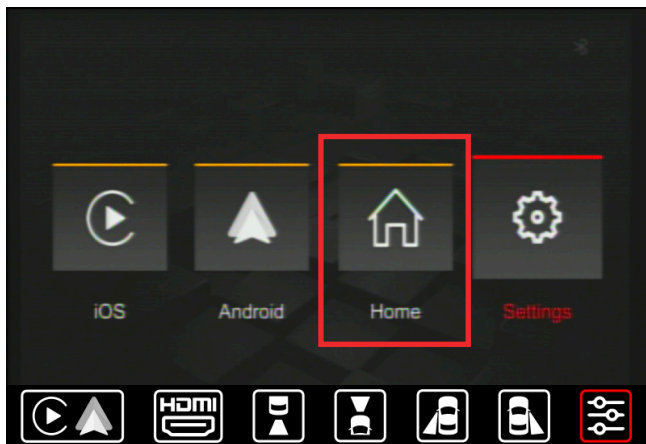

- Touch the Home button to reveal NavTool menu bar.
- Touch the settings menu option.
- The menu option is the last icon on the bottom right.

Step: 1

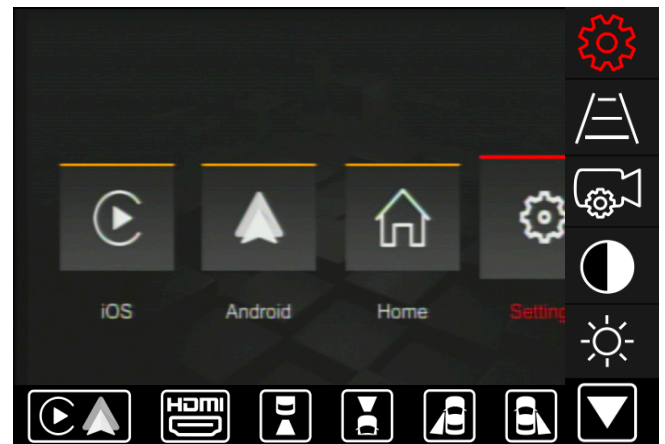

- Touch the settings gear.
- The settings gear is the top icon.

Step: 2

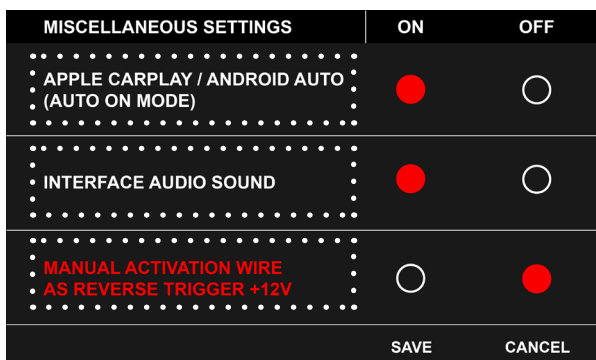

To change features ON or OFF, touch the text on the screen that is indicated in the image with the dotted outline.

- Touch the text "Manual Activation Wire as Reverse Trigger +12V."
- Change the setting to OFF, once the red dot is set to OFF (image shown on the left), click the SAVE button on the bottom right.



Apple CarPlay/Android Auto (Auto ON Mode) only set it to ON if you do not plan to use HDMI or video inputs

Step: 3

# Testing and Settings

## STEP 6

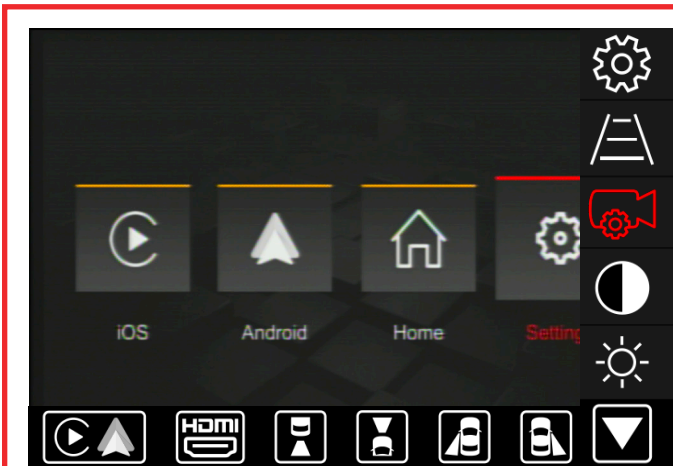

### Camera Settings

- Touch the Camera Settings icon.

**Step: 1**

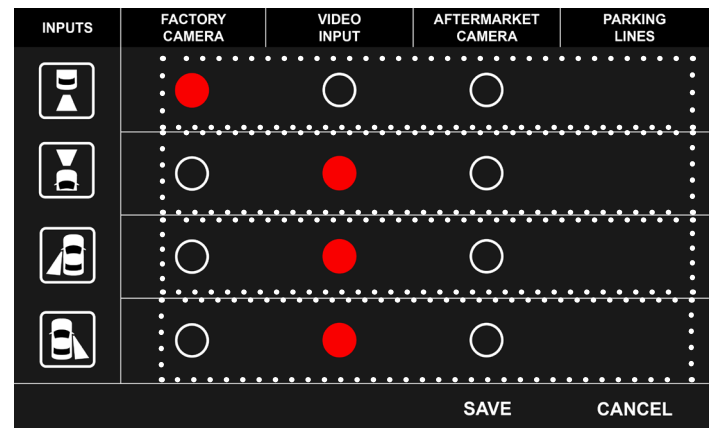



### Camera Settings

- Image above shows you typical camera settings.
- To change camera input, touch the desired line of the camera as indicated in the image above. (rear, front, left, or right). Tap repeatedly to change the options for your camera input.
- Once all camera inputs are set, tap the SAVE button on the bottom right.

**Step: 2**

To change the camera input settings, touch the area on the screen that is indicated in the image with the dotted outline.

-  Set vehicle in reverse gear to test the operation of the factory rear view camera.
-  Press and hold one of the four corners of the touch screen for 3 seconds to turn OFF the NavTool interface. Press and hold the corner of the touch screen for a few seconds until the bottom menu appears on the screen, release the finger and hold the corner of the screen again to return to the factory menu. (See page 18 for details)

## STEP 7

- Press and hold one of the four corners with your thumb for 3 seconds to activate the interface. (See page 18 for details)
- Select Apple CarPlay or Android Auto option depending on your phone.
- Plug in or pair your smartphone wireless to connect Apple CarPlay/Android Auto feature.
- Once your phone is paired or connected via USB cable, Apple CarPlay or Android Auto will appear.

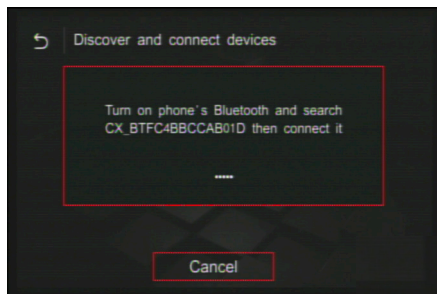
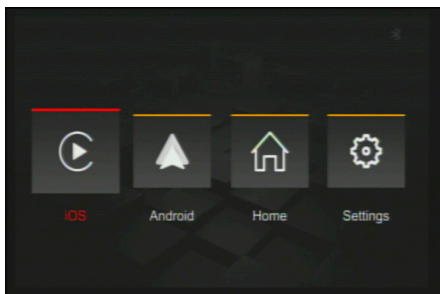

# Testing and Settings

## STEP 7 Continued

• Once your phone is paired wireless or connected via USB cable, Apple CarPlay or Android Auto will appear.

 If your phone is paired to vehicle bluetooth system for calling, please go into your smartphone bluetooth settings, find your vehicle and do Forget This Device.

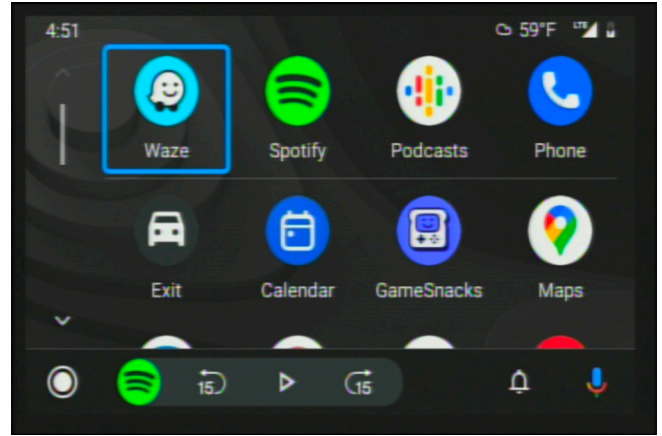
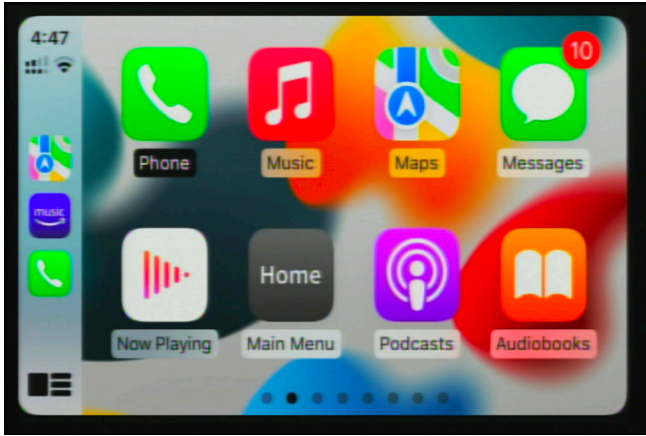

• Do a test call, check that another party hears your voice. If required, adjust microphone sensitivity higher or lower. Typically if you are heard too loud, you may want to lower the sensitivity. If your voice is too low, you may want to increase the sensitivity. (See page 26)

 This test will verify that microphone is working, and audio from car speakers is present.

## STEP 8

• Test HDMI input if you are connecting any HDMI video source. To bring up the bottom menu, press and hold one of the four touch screen corners for 3 seconds.



• Touch the HDMI button on the screen to enter the HDMI input of the interface.  
• Video signal from your HDMI source will appear on the screen. If no video source is connected or the connected source is not correctly working, you will see this message.

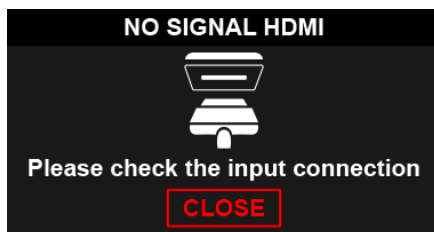

• Test AV inputs by selecting them in the menu of the interface or if you are installing any aftermarket cameras.  
• To test aftermarket front camera, put the car in reverse then into drive. Front camera should display on the screen.  
• To test aftermarket left and right cameras, use left and right turn signals. Left and right cameras should display depending on the turn signal activated.  
• To exit HDMI input or any Camera inputs, tap the touch screen to bring up the bottom menu.

 After everything is tested and working, reassemble the vehicle.

# Vehicle Reassembly Checklist

When performing vehicle reassembly, please make sure to go over the list and checkoff check mark boxes:

- Check to see if all connectors behind the screen, radio, HVAC etc. were reconnected.
- Check that LCD screen shuts off with the key off, and turns back on with the key on.
- Check touchscreen operation.
- Check Heat and AC controls operation.
- Check AM/FM/SAT radio reception.
- Check CD player/changer operation.
- Check GPS signal reception.
- Check cigarette lighter or +12V power source for accessory or constant power.
- Check to see if any other panels that were removed during installation and now being reassembled have all and any electrical connectors reconnected.
- Turn on parking light and check all dashboard lights operation.
- Check all panels for proper fit, make sure no gaps in panels are left behind.

If all steps above are checked off, you will save time, money and have an extremely happy customer.

All above steps eliminate any unnecessary customer comebacks to your shop.

If you require any further assistance please call our tech support line, email or go online

[WWW.NAVTOOL.COM](http://WWW.NAVTOOL.COM)

1-877-628-8665

[techsupport@navtool.com](mailto:techsupport@navtool.com)

# Interface Menus and Settings



NavTool Interface Screen

Press and hold one of the four corners of the touch screen to activate or deactivate NavTool interface. After you activated the interface, you will be brought to this screen that you can navigate using the factory touch screen. (See page 18)

# Interface Menus and Settings



## Apple CarPlay/Android Auto

Tap the Apple CarPlay/Android Auto button to enter the option.

After selecting Apple CarPlay/Android Auto you will be brought to your Apple CarPlay/Android Auto screen.

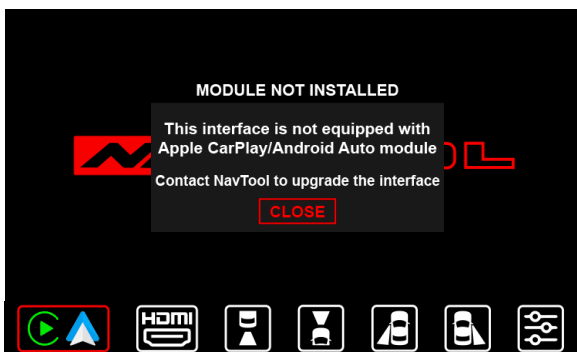

## Apple CarPlay/Android Auto Module Not Installed

You will get this message when selecting this option on the NavTool interface that is not equipped with Apple CarPlay/Android Auto module.

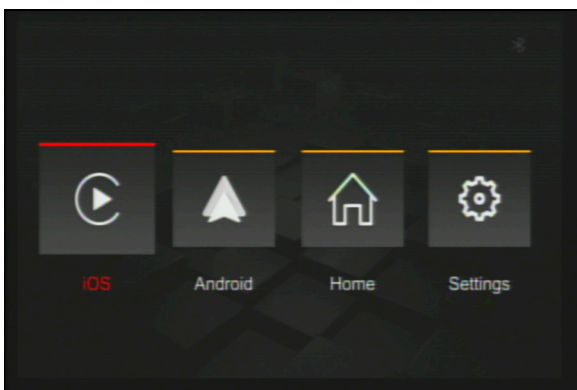

## Apple CarPlay

Tap the icon shown on the image in the left to enter the option.

Selecting this option will take you to your Apple CarPlay screen.

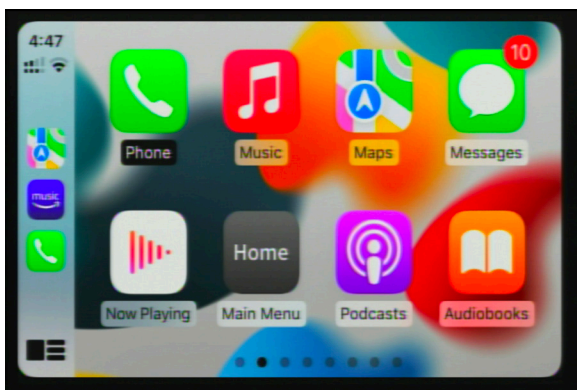

## Apple CarPlay Screen

Example of Apple CarPlay screen.

Apple CarPlay is controlled via factory touch screen. Tap the touch screen to navigate and select.



# Interface Menus and Settings

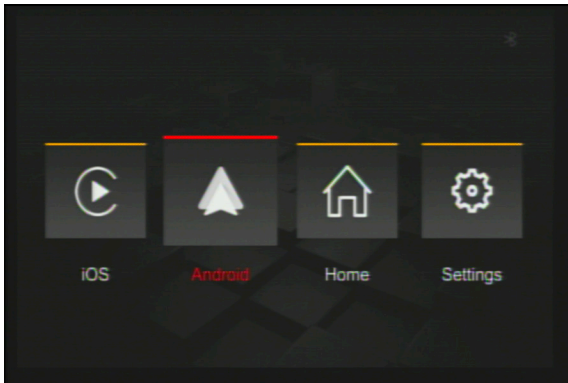

## Android Auto

Tap the icon shown on the image in the left to enter the option.

Selecting this option will take you to your Android Auto screen.

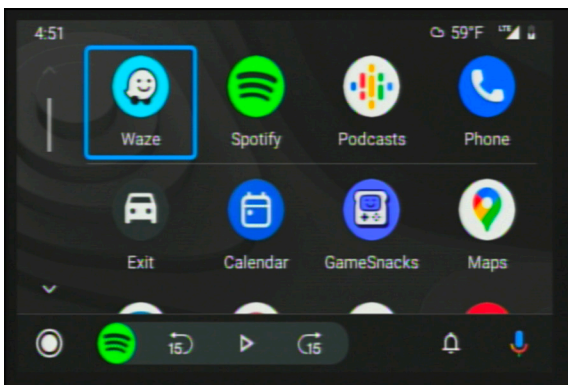

## Android Auto Screen

Example of Android Auto screen.

Android Auto is controlled via factory touch screen. Tap the touch screen to navigate and select.

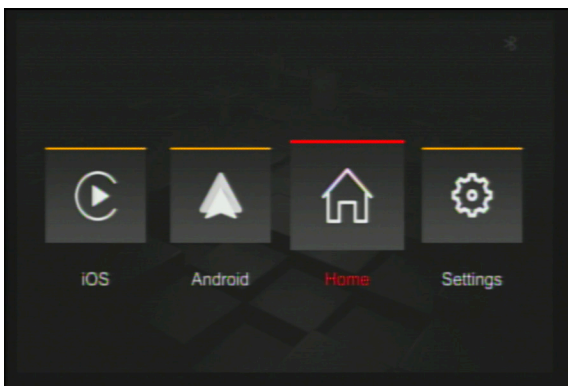

## Home

Press and hold one of the four corners of the touch screen to return back to the NavTool interface.

Selecting the Home option will take you back to the bottom NavTool interface menu.

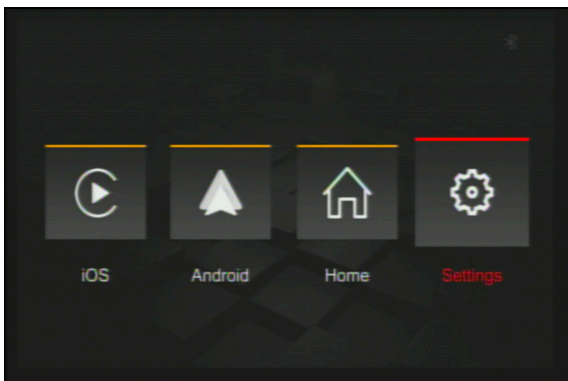

## Settings

Tap the icon shown on the image in the left to enter the option.

Selecting this option will allow you to change your Apple CarPlay and Android Auto settings.

# Interface Menus and Settings

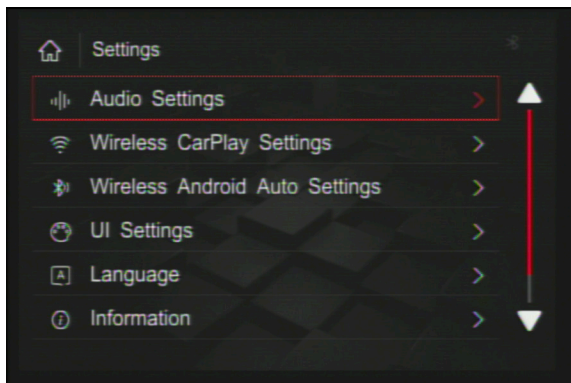

## Audio Settings.

Selecting this option will let you change your audio settings.

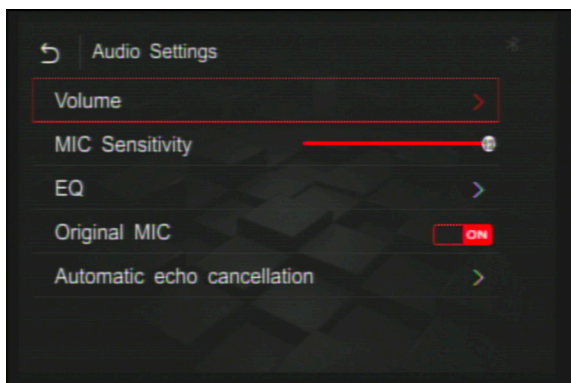

## Audio Settings- Volume

Selecting this option will let you change different volume settings.

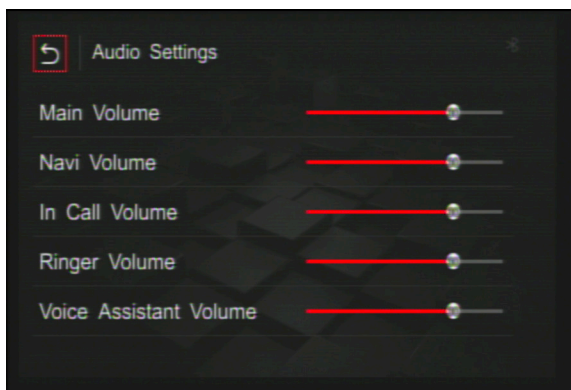

## Volume

Drag the volume bars left or right to increase or decrease the volume.

You can change your main volume, navigation volume, call volume, ringtone volume, and voice assistant volume.

Tap the back arrow in the top left of the screen to go back to your audio settings.

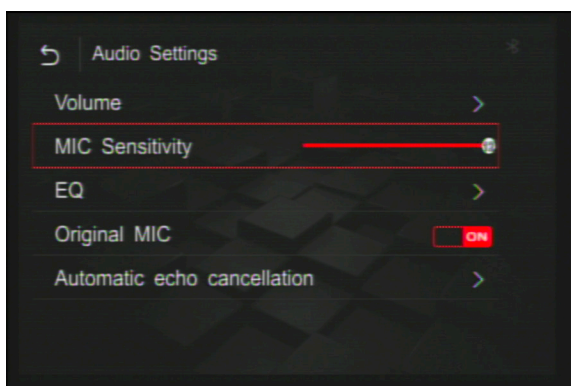

## Audio Settings- MIC Sensitivity

Drag the MIC Sensitivity bar left or right to increase or decrease the sensitivity.

You can change the sensitivity of the microphone to make it more or less sensitive. Make a test call and ask the person how they hear you. If they hear too much noise, you want to make it less sensitive all the way down to 1 or 2. If they don't hear you loud enough, you can increase sensitivity to a desired level.

# Interface Menus and Settings

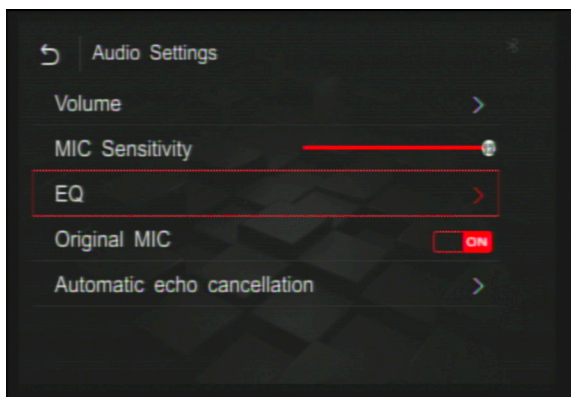

## Audio Settings- EQ

Tap the EQ to enter this option.

Selecting this option will let you adjust the interfaces EQ.



## EQ

Tap the up or down arrows to change EQ bands. You can also drag each of the bars manually.

You can also choose from preset EQ settings.

Tap the back arrow on the top left to return to the Audio Settings.

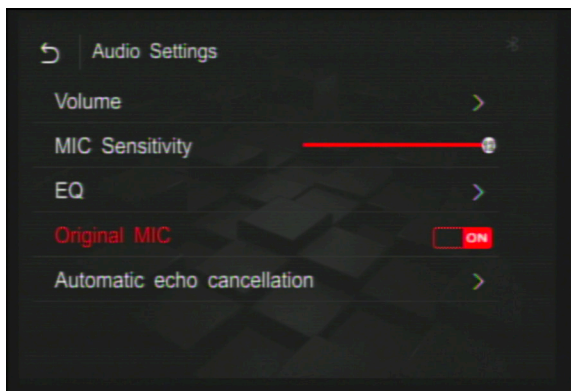

## Audio Settings- Original MIC ON

Tap Original MIC to turn ON Original MIC

Only set this setting to ON if your vehicle is equipped with a compatible factory microphone and your interface was not supplied with an external microphone.

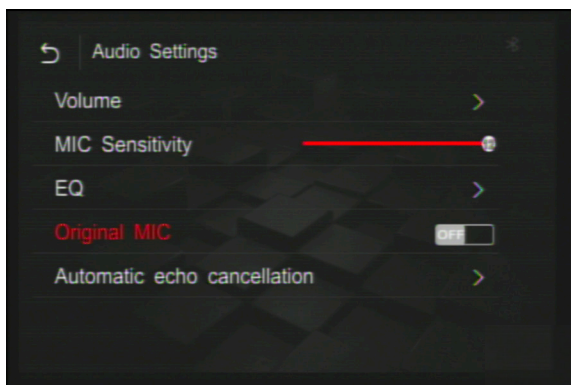

## Audio Settings- Original MIC OFF

Tap Original MIC to turn OFF Original MIC

Only set this setting to OFF if your vehicle is not equipped with a compatible factory microphone and your interface was supplied with an external microphone.

# Interface Menus and Settings

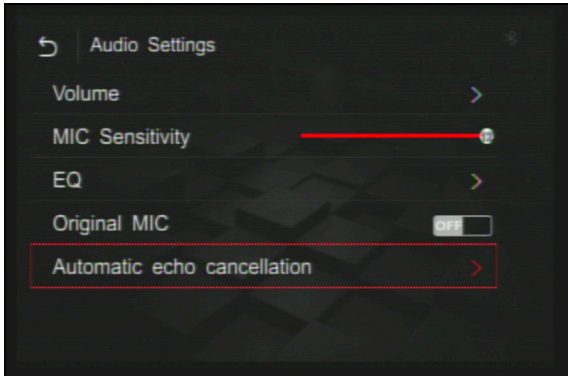

## Audio Settings- Automatic Echo Cancellation

Enter this setting to adjust echo cancellation

Tap the back arrow on the top left to return to the settings.

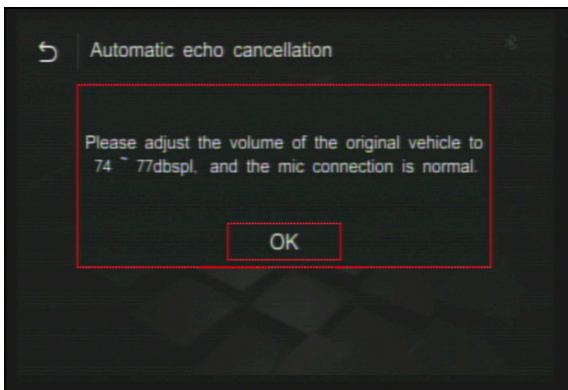

## Automatic Echo Cancellation

Follow the prompt on the screen if you need to know how to set the vehicle to 74 ~ 77 db, you can find an app on the app store that measures db levels.

Tap the back arrow on the top left to return to the audio settings.

**For most installations, there is no need to enter below menus**

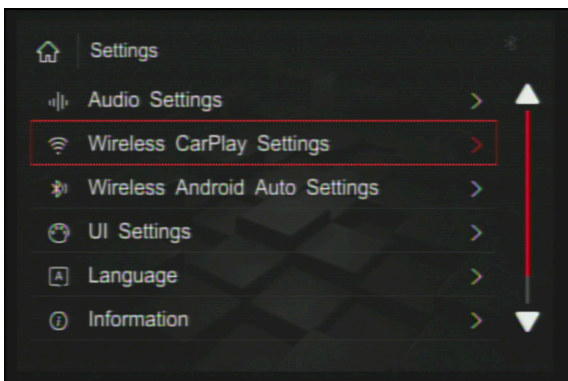

## Wireless CarPlay Settings

Tap wireless CarPlay Settings

Selecting this option will let you change your Apple CarPlay settings.



## Wireless CarPlay Connection

Tap Wireless CarPlay Connection

You can select this option to change wireless CarPlay option ON or OFF.

# Interface Menus and Settings

For most installations, there is no need to enter below menus

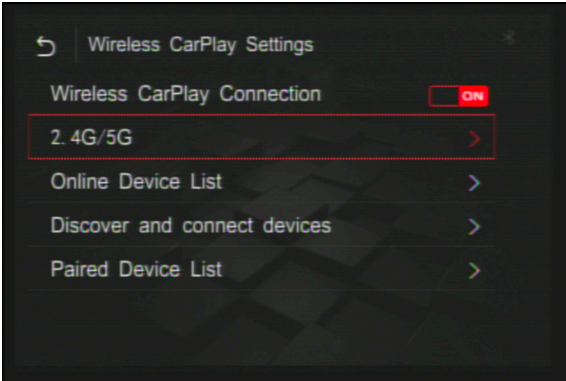

## Wireless CarPlay Settings- 2.4G/5G

Tap 2.4G/5G to enter this option.

You can change between 2.4G and 5G wireless connection, default option is 5G.

There is no need to enter this option and change anything, the default setting will work on all phones.

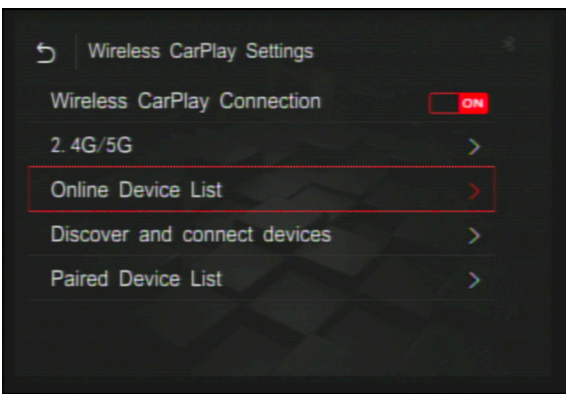

## Wireless CarPlay Settings- Online Device List

Tap Online Device List to enter this option.

In this option, you can see currently paired devices.

There is no need to enter this option unless you need to delete a phone in the future.

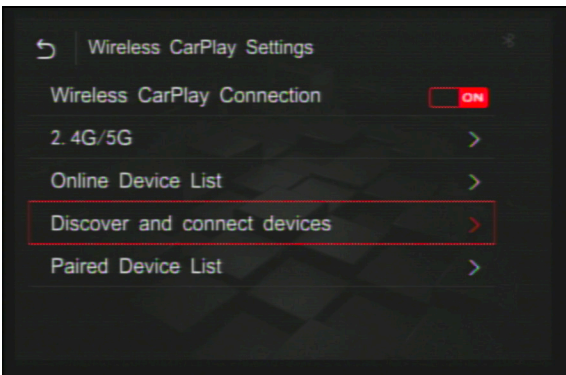

## Wireless CarPlay Settings- Discover and Connect Devices

Tap Discover and Connect Devices to enter this option.

This option lets you connect your iPhone wirelessly for wireless Apple CarPlay option.

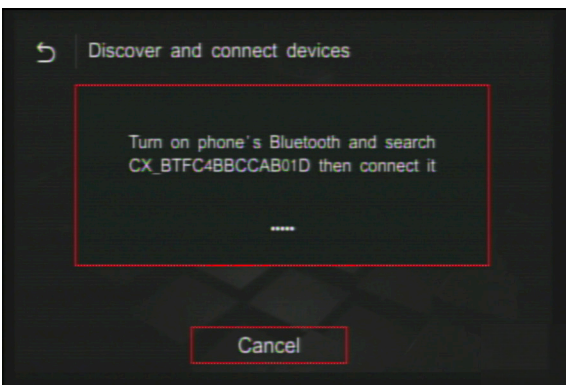

## Discover and Connect Devices

After selecting Discover and Connect Devices, you will have a Bluetooth connection available for your phone to connect to and pair to the interface.

Tap the back arrow on the top left to return to Wireless CarPlay Settings.

# Interface Menus and Settings

For most installations, there is no need to enter below menus



## Wireless CarPlay Settings- Paired Device List

Tap Paired Device List to enter this option. In this option, you can see all paired devices.

There is no need to enter this option unless you need to delete a phone in the future.

Tap the back arrow on the top left to return to interface Settings.

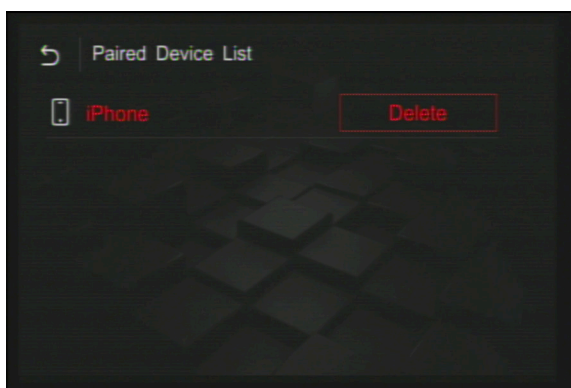

## Paired Device List

Tap delete button to delete a device from the paired device list.

There is no need to enter this option unless you need to delete a phone in the future.

Tap the back arrow on the top left to return to the Wireless Apple CarPlay settings.

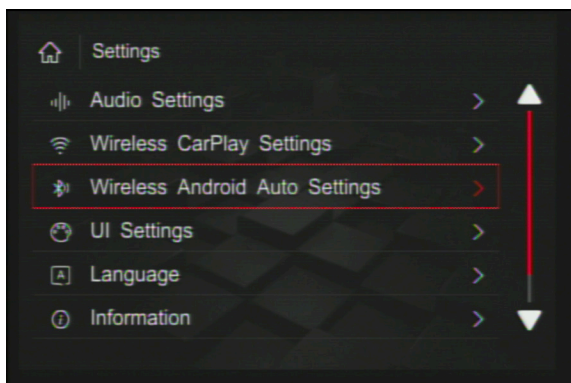

## Wireless Android Auto Settings

Tap Wireless Android Auto Settings to enter this option.

Selecting this option will let you change your Android Auto settings.

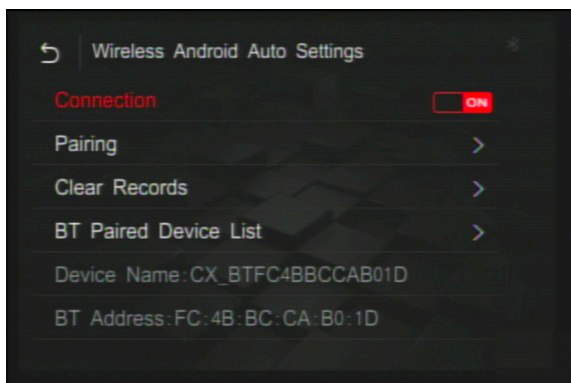

## Wireless Android Auto Settings- Connection

You can tap and select this option to change wireless Android Auto option ON or OFF.

# Interface Menus and Settings

For most installations, there is no need to enter below menus

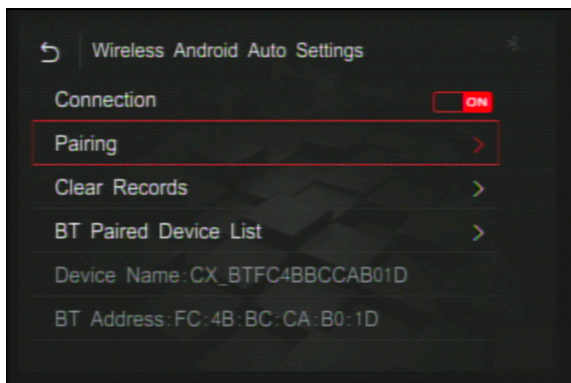

## Wireless Android Auto Settings- Pairing

Tap Pairing to enter this option.

This option lets you connect your android wirelessly for wireless Android Auto option.

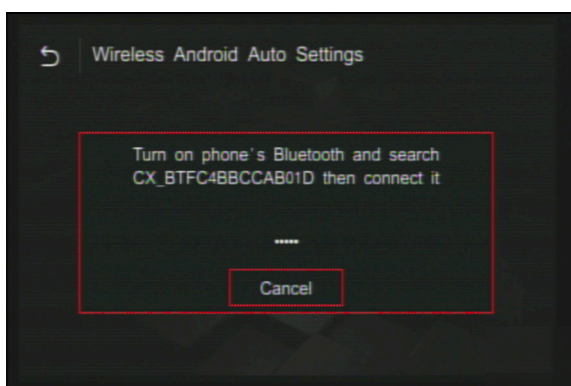

## Pairing

After selecting Pairing, you will have a Bluetooth connection available for your phone to connect to and pair to the interface.

Tap the back arrow on the top left to return to the Android Auto settings.

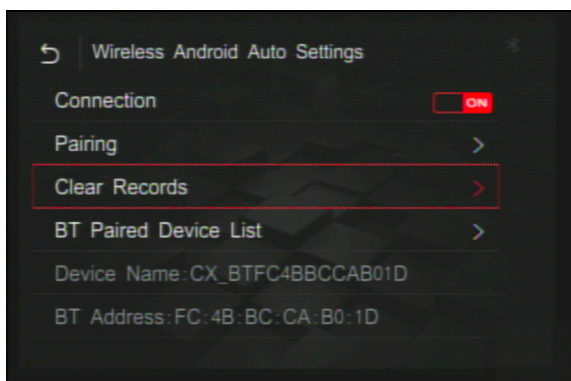

## Wireless Android Auto Settings- Clear Records

Tap Clear Records to enter this option.

In this option, you can see all paired devices.

There is no need to enter this option unless you need to delete a phone in the future.

Tap the back arrow on the top left to return to the interface settings.

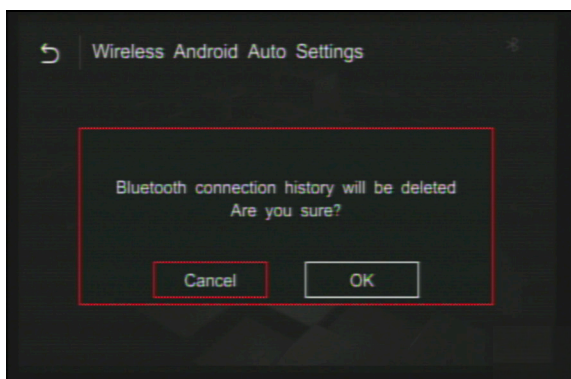

## Clear Records

Tap Cancel or Tap OK if you want to delete all previous Bluetooth connection history.

There is no need to enter this option unless you need to delete a phone in the future.

Tap the back arrow on the top left to return to the Android Auto settings.

# Interface Menus and Settings

For most installations, there is no need to enter below menus

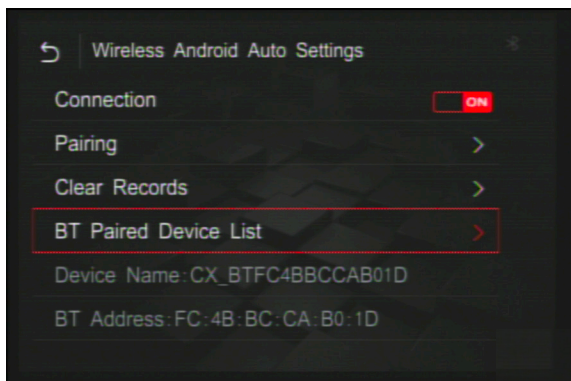

## Wireless Android Auto Settings- BT Paired Device List

Tap BT Paired Device List to enter this option.

In this option, you can see currently paired devices.

There is no need to enter this option unless you need to delete a phone in the future.

Tap the back arrow on the top left to return to the interface settings.

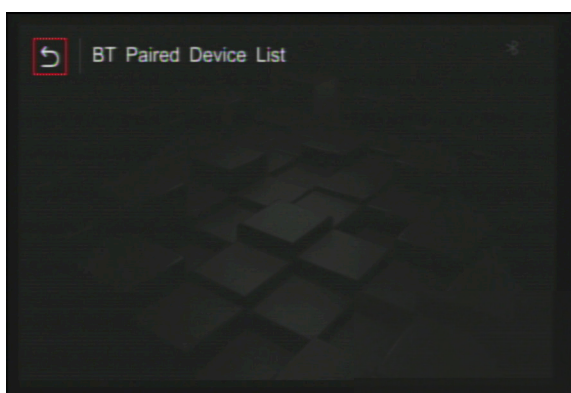

## Bluetooth Paired Device List

Select delete for any of the devices you wish to delete from the paired device list.

There is no need to enter this option unless you need to delete a phone in the future.

Tap the back arrow on the top left to return to the Android Auto settings.

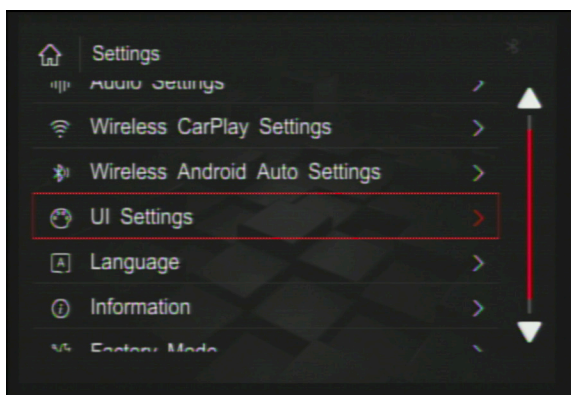

## UI Settings

Tap the UI Settings to enter this option.

Selecting this will allow you to change the UI settings of the interface.

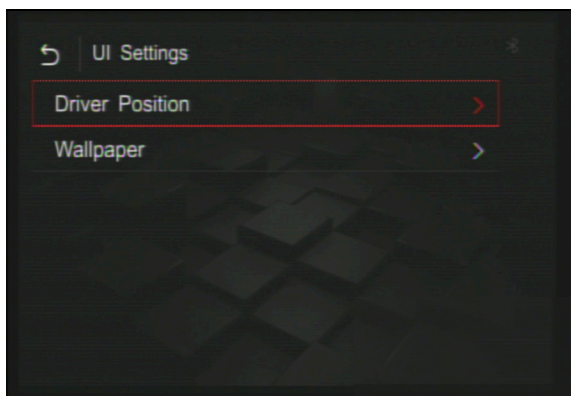

## UI Settings- Driver Position

Tap the Driver Position to enter this option.

You can select or change which driver position you are in.



# Interface Menus and Settings

For most installations, there is no need to enter below menus

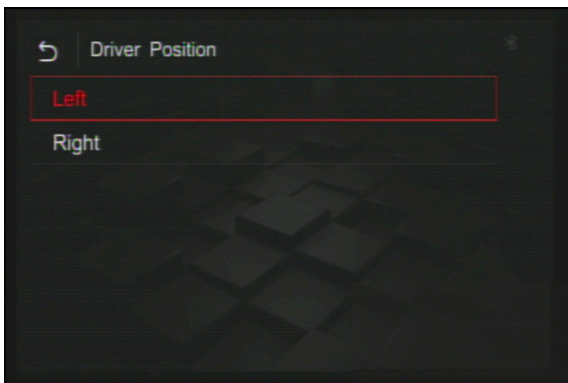

## Driver Position

Tap Left or Right to select the driver position in the vehicle. This will also move the menu position of Apple CarPlay/ Android Auto on left or right in case something is blocking the menu.

Tap the back arrow on the top left corner to go back to the UI settings.

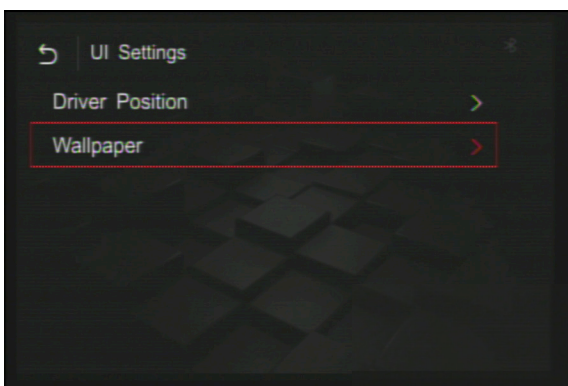

## UI Settings- Wallpaper

Tap the Wallpaper to enter this option.

After selecting this, you can change the wallpaper you want to have displayed on the interface.

Tap the back arrow on the top left corner to go back to the Interface settings.

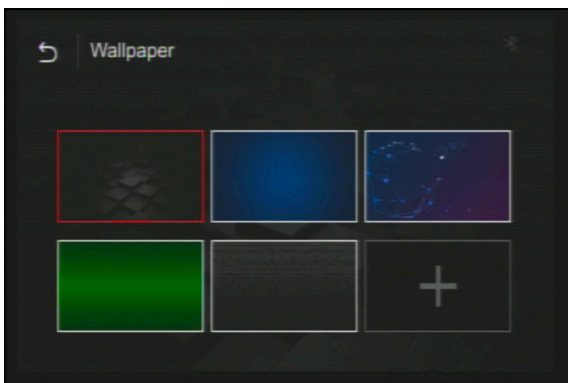

## Wallpaper

Tap which wallpaper you want to have displayed on the interface.

Tap the back arrow on the top left corner to go back to the UI settings.

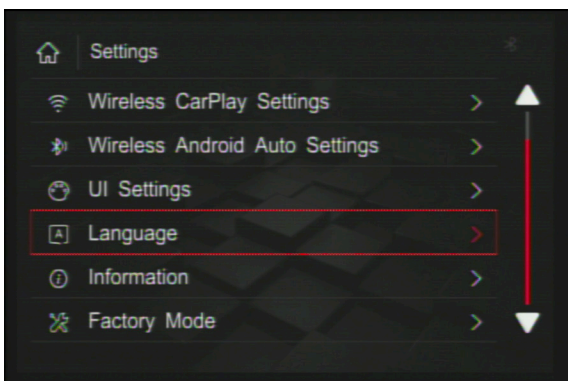

## Language

Tap Language to enter this option.

You can select this to change the language of the interface.

# Interface Menus and Settings

For most installations, there is no need to enter below menus

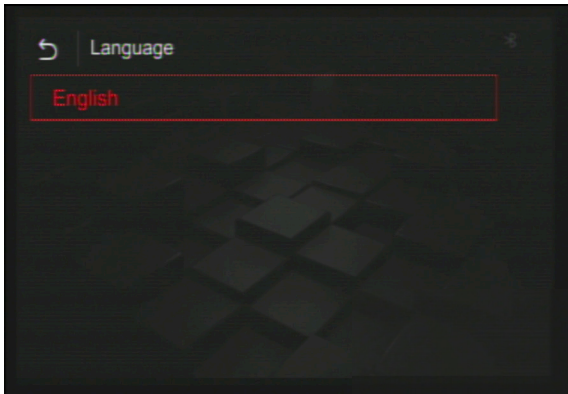

## Language

Selection screen for the language setting. Tap to change what language the interface is set to.

Tap the back arrow on the top left corner to go back to the interface settings.

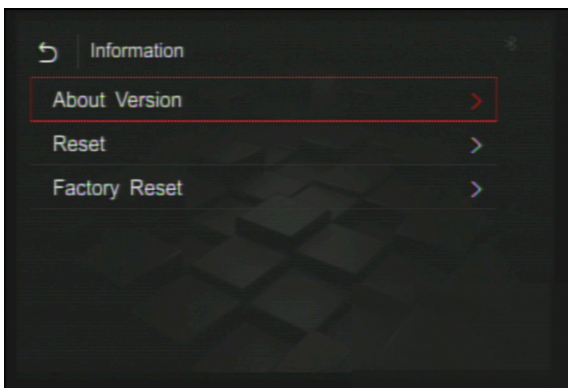

## Information

Tap Information to see information about the interface.

After selecting information, you can find more information about the interface version, and the ability to reset or factory reset.

Tap the back arrow on the top left corner to go back to your interface settings.

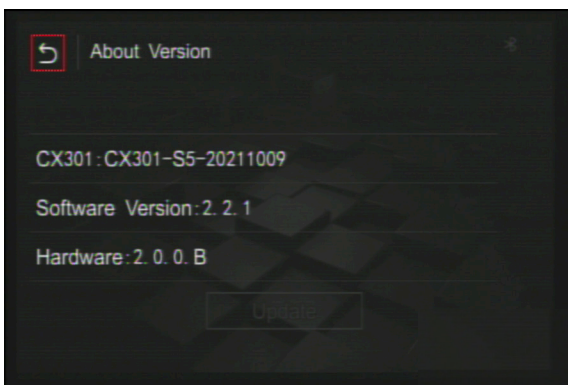

## About Version

Tap About Version to enter this option.

After selecting information, you can find more information about the interface version.

Tap the back arrow on the top left corner to go back to the information settings.

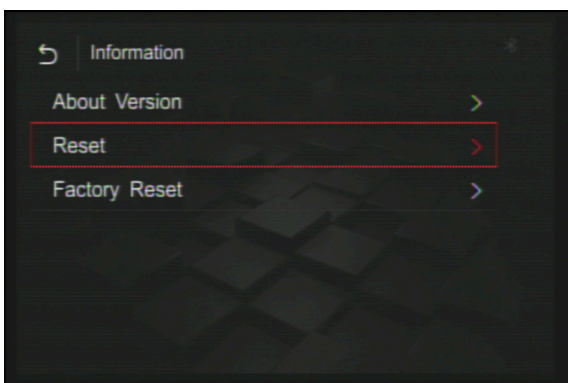

## Reset

Tap Reset to enter this option.

Selecting this will let you reset the interface options.

Tap the back arrow on the top left corner to go back to the interface settings.

# Interface Menus and Settings

For most installations, there is no need to enter below menus

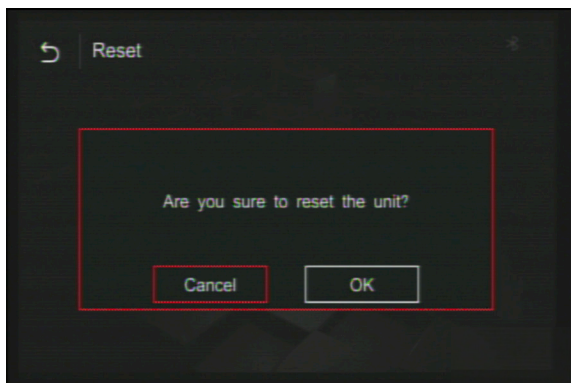

## Reset

Tap Cancel or OK if you want to reset the interface unit and the options you have changed.

Tap the back arrow on the top left corner to go back to the information settings.

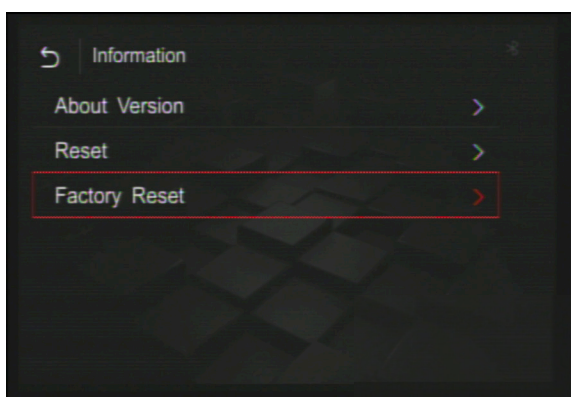

## Information- Factory Reset

Tap Factory Rest to enter this option.

Selecting this will allow you to factory reset your interface.

Tap the back arrow on the top left corner to go back to the interface settings.

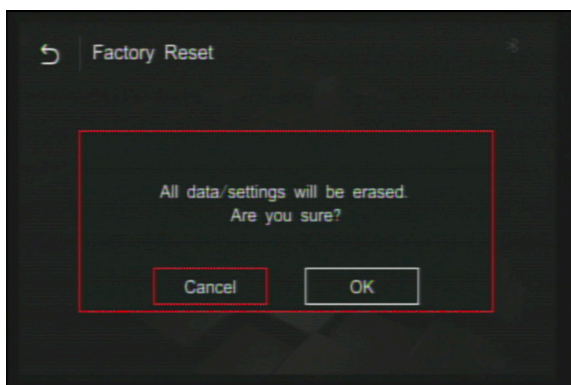

## Factory Reset

Tap Cancel or OK if you want to factory reset the interface. This will erase all data and settings that were previously on it.

Tap the back arrow on the top left corner to go back to the information settings.

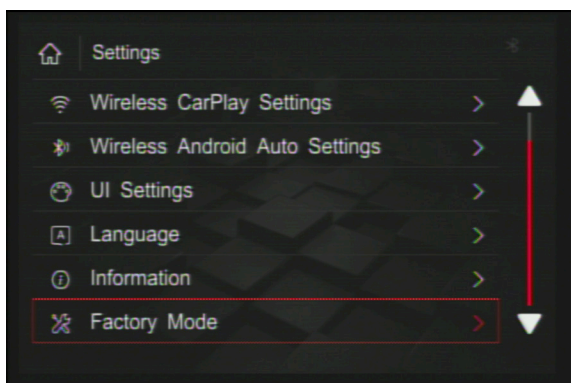

## Factory Mode

Do not enter this mode as it is password protected and changing any features will break the interface.

Tap the Home icon on the top left of the screen to return to the main menu.

# Interface Menus and Settings

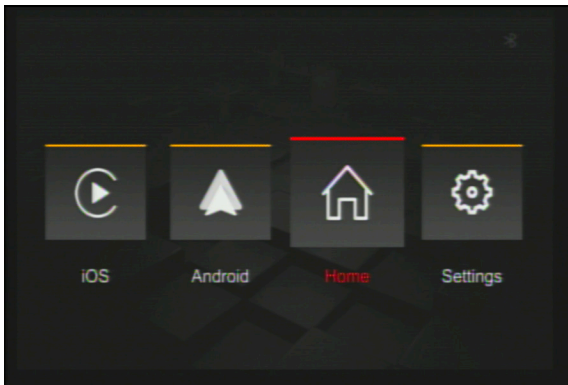

## Home

Tap the Home button to bring up the bottom NavTool menu bar.

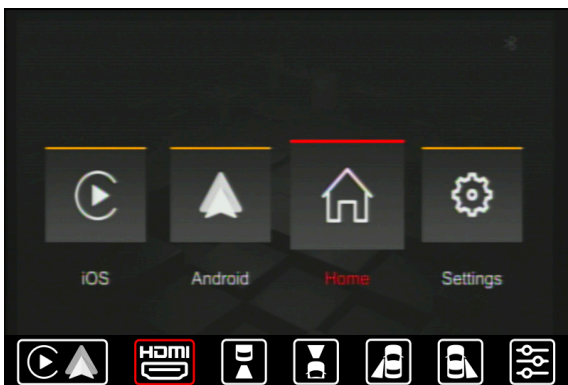

## HDMI

Tap the HDMI button to enter this option.

After selecting HDMI with a HDMI source attached, you will be brought to your HDMI's device screen and connected image will appear on the screen.

To exit HDMI, tap the touch screen to bring up the bottom menu.

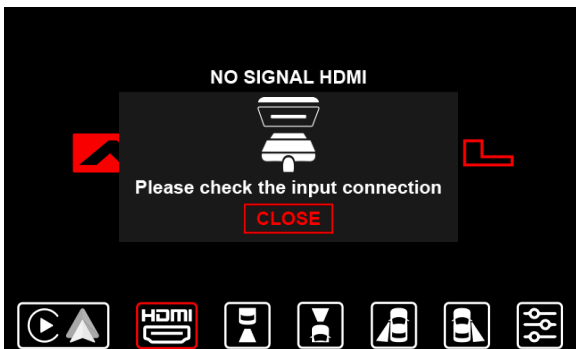

## No HDMI Signal

You will get this message when selecting this input with no HDMI source connected to interface.

This part of the page has been intentionally left blank

# Interface Menus and Settings



## Back-Up Camera

Tap the Back-Up Camera button to enter this option.

After selecting the back-up camera input, you will be brought to your back up camera screen. This will not work if a back-up camera is not installed. (Note: This input will not display factory installed rear-view camera)

To exit Back-Up Camera, tap the touch screen to bring up the bottom menu.



## Front Camera

Tap the Front Camera button to enter this option.

After selecting the front camera input, you will be brought to your front camera screen. This will not work if a front camera is not installed. (Note: This input will not display factory installed forward facing camera)

To exit Front Camera, tap the touch screen to bring up the bottom menu.

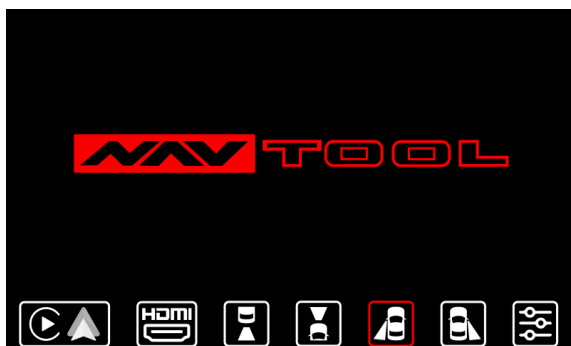

## Left Lane Watch Camera

Tap the Left Lane Watch Camera button to enter this option.

After selecting the left lane watch camera input, you will be brought to your left lane watch camera screen. This will not work if a left lane watch camera is not installed. (Note: This input will not display factory installed left lane watch camera)

To exit Left Lane Watch Camera, tap the touch screen to bring up the bottom menu.



## Right Lane Watch Camera

Tap the Right Lane Watch Camera button to enter this option.

After selecting the right lane watch camera input, you will be brought to your right lane watch camera screen. This will not work if a right lane watch camera is not installed. (Note: This input will not display factory installed right lane watch camera)

To exit Right Lane Watch Camera, tap the touch screen to bring up the bottom menu.

# Interface Menus and Settings



## Settings

Tap the Settings Menu button to enter this option.

After selecting the settings option, a menu will expand showing different interface settings you can change.



## Settings Options Menu

The Settings Menu button will change to a down arrow once clicked on. Tap the down arrow button to close the Settings Menu.

Selecting the setting options input, you will have access to change brightness, contrast, camera settings, parking line settings, and interface settings. You can close this by selecting the down arrow.

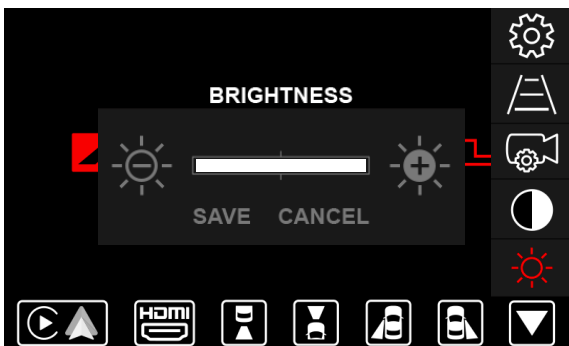

## Brightness

Tap the Brightness button to enter this option.

After selecting brightness, you can adjust the brightness of the interface. The white bar in the middle shows the interface brightness setting. You can lower the brightness of the interface by tapping the minus on the left and increase the interface's brightness by tapping the plus on the right. Save or cancel any changes you have made.

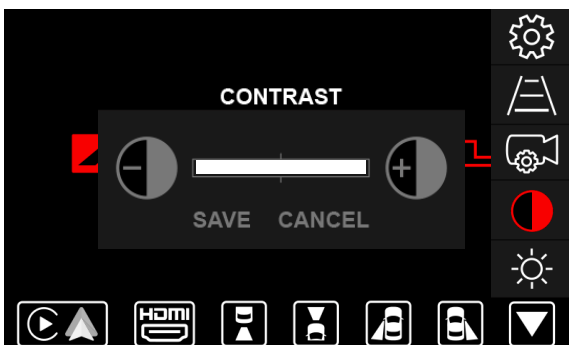

## Contrast

Tap the Contrast button to enter this option.

After selecting contrast, you can adjust the contrast of the interface. The white bar in the middle shows the interface contrast setting. You can lower the contrast of the interface by tapping the minus on the left and increase the interface's contrast by tapping the plus on the right. Save or cancel any changes you have made.

# Interface Menus and Settings



## Camera Settings

Tap the Camera Settings button to enter this option.

### Camera Settings Menu

Tap to select a particular camera input. Tap repeatedly to change the option to what you want for that particular camera input.

**Factory camera:** Select this option if your vehicle is equipped with a factory installed rear view camera.

**Video input:** Select this option if your vehicle is not equipped with a factory rear view camera and you are not planning to add a aftermarket camera or if you wish to use this input as a video input.

**Aftermarket camera:** Select this option if you are installing an aftermarket rear view camera.

**Parking lines:** Select this option if you are installing an aftermarket rear view camera and you wish to add distance lines to the camera image.

**Factory camera:** Select this option if your vehicle is equipped with a factory installed forward facing camera. Do not select this option if your vehicle is equipped with 360 degree parking cameras, 360 degree front parking camera is not considered forward facing camera.

**Video input (Select for most installations):** Select this option if your vehicle is not equipped with a factory forward facing camera and you are not planning to add a aftermarket camera or if you wish to use this input as a video input.

**Aftermarket camera:** Select this option if you are installing an aftermarket forward facing camera.

**Parking lines:** Select this option if you are installing an aftermarket forward facing camera and you wish to add distance lines to the camera image.

INPUTS	FACTORY CAMERA	VIDEO INPUT	AFTERMARKET CAMERA	PARKING LINES
	<input type="radio"/>	<input type="radio"/>	<input type="radio"/>	<input type="radio"/>
	<input type="radio"/>	<input type="radio"/>	<input type="radio"/>	<input type="radio"/>
	<input type="radio"/>	<input type="radio"/>	<input type="radio"/>	<input type="radio"/>
	<input type="radio"/>	<input type="radio"/>	<input type="radio"/>	<input type="radio"/>
				SAVE CANCEL

**Factory camera:** Select this option if your vehicle is equipped with a factory installed right lane watch camera. Do not select this option if your vehicle is equipped with 360 degree parking cameras, 360 degree right parking camera is not considered forward facing camera.

**Video input (Select for most installations):** Select this option if your vehicle is not equipped with a factory right lane watch camera and you are not planning to add a aftermarket camera or if you wish to use this input as a video input.

**Aftermarket camera:** Select this option if you are installing an aftermarket right lane watch camera.

**Parking lines:** Select this option if you are installing an aftermarket right lane watch camera and you wish to add distance lines to the camera image.

**Factory camera:** Select this option if your vehicle is equipped with a factory installed left lane watch camera. Do not select this option if your vehicle is equipped with 360 degree parking cameras, 360 degree front parking camera is not considered forward facing camera.

**Video input (Select for most installations):** Select this option if your vehicle is not equipped with a factory left lane watch camera and you are not planning to add a aftermarket camera or if you wish to use this input as a video input.

**Aftermarket camera:** Select this option if you are installing an aftermarket left lane watch camera.

**Parking lines:** Select this option if you are installing an aftermarket left lane watch camera and you wish to add distance lines to the camera image.

# Interface Menus and Settings

For most installations, there is no need to enter below menus

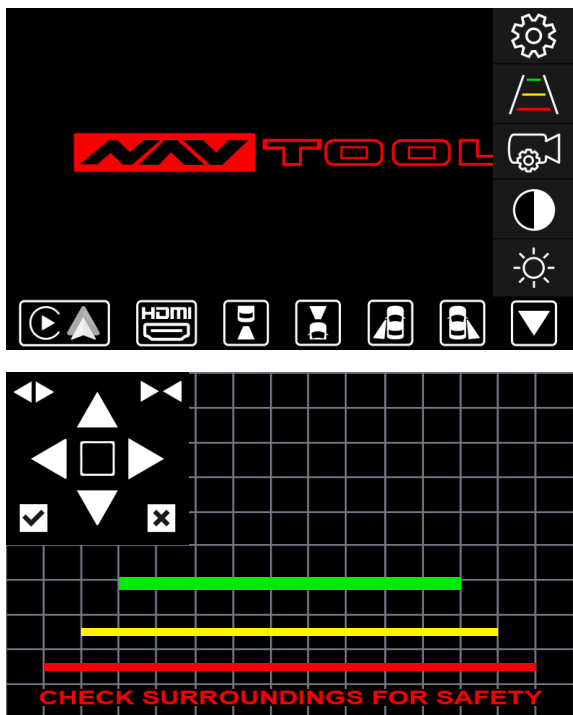

## Parking Line Settings

(These line adjustments are only for aftermarket cameras, they do not affect factory cameras)

Tap the Parking Line Settings button to enter this option.

You can only access this setting when you are on the particular camera input. Select the camera input prior to going into parking line settings.

## Parking Line Settings

After selecting parking line settings, you can adjust the parking lines of the interface. Your interface will display which camera input you chose with gridlines instead of a black background. You can choose which parking line you want to make changes to by selecting the square in the middle. The white circle in the square indicates which parking line you are making changes to.



### Increase Line Width

You can increase your parking line width to a desired size.

**Up**  
You can move your parking lines up by selecting the up arrow for your selected parking line.

### Decrease Line Width

You can decrease your parking line width to a desired size.

### Left

You can move your parking lines left by selecting the left arrow for your selected parking line.

### Right

You can move your parking lines right by selecting the right arrow for your selected parking line.

### Save

After making changes to your parking line settings, select the check to save your changes.

### Down

You can move your parking lines down by selecting the down arrow for your selected parking line.

### Cancel

After making changes to your parking line settings, select the X to cancel your changes.



# Interface Menus and Settings



## Interface Settings

Tap the Interface Settings icon to enter this option.

After selecting interface settings, you can adjust miscellaneous settings of the interface. Save or cancel any interface changes.

Set this feature to ON if you want to directly enter into the Apple CarPlay/Android Auto mode when activating the interface, and bypassing the NavTool menu. Do not select this mode if you plan to use HDMI input or if you want to view other video inputs.

Set this feature to OFF if you want to enter NavTool menu upon activation of the interface.

MISCELLANEOUS SETTINGS	ON	OFF
APPLE CARPLAY / ANDROID AUTO (AUTO ON MODE)	<input type="radio"/>	<input type="radio"/>
INTERFACE CHIRP SOUND	<input type="radio"/>	<input type="radio"/>
MANUAL ACTIVATION WIRE AS REVERSE TRIGGER +12V	<input type="radio"/>	<input type="radio"/>
	SAVE	CANCEL

Turn this feature to ON to enable audio feedback from the interface when activating the interface or when smartphone wireless connection is established.

Turn this feature to OFF if audio feedback from the interface is not required.

Turn ON manual activation wire as reverse trigger if your manual tells you to or if done by an installer. (See page 19 for details)

Turn OFF: Most vehicles will have the manual activation wire turned OFF. (See page 19 for details)

# How to Connect Rear Screens to Car With AV Input

Examples of equipment used if connecting or installing additional rear screens



Car Monitor

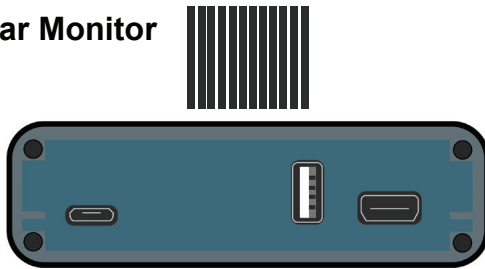

NavTool Interface



HDMI to AV Adaptor



1 in 2 Out HDMI Splitter



HDMI Sources

# How to Connect Rear Screens to Car With HDMI Input

Examples of equipment used if connecting or installing additional rear screens



Car Monitor



NavTool Interface



Car HDMI Input

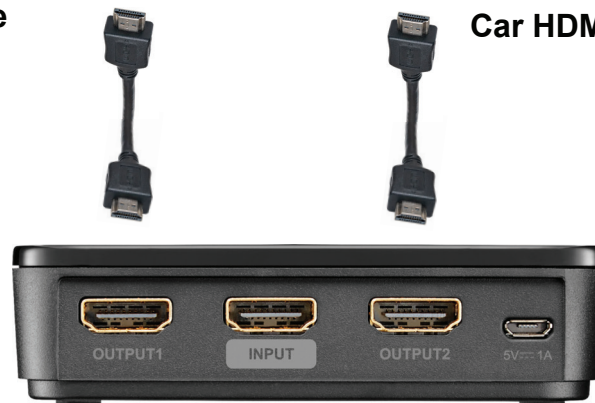

1 in 2 Out HDMI Splitter



HDMI Sources

# User Manual

## Setting Radio to Auxiliary

Plug the NavTool supplied AUX Activator (Part # NT-AUX-ACT) into vehicle's 3.5mm AUX jack. See number 13 on the drawing below.

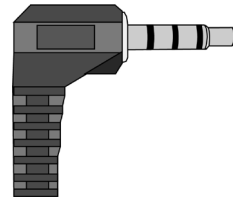
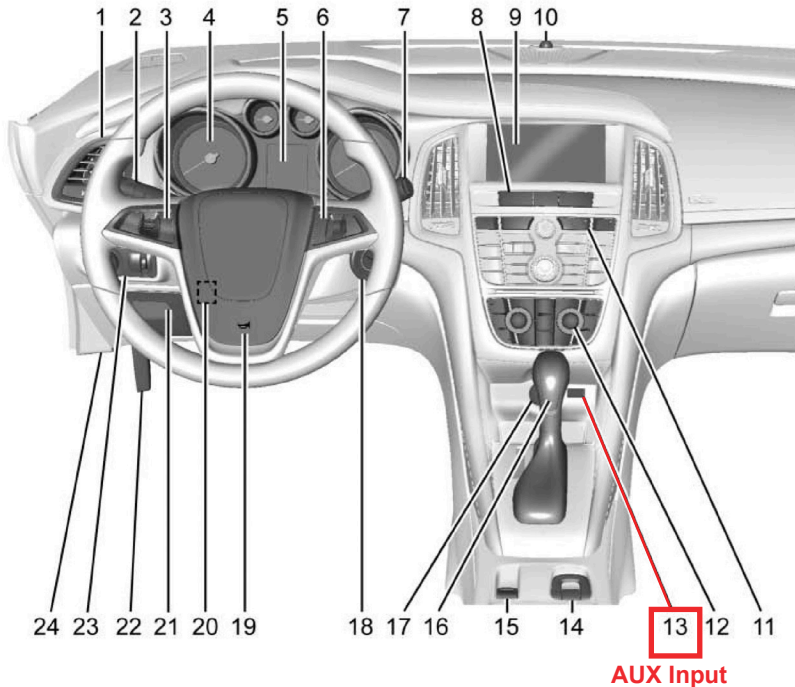

NavTool supplied AUX Activator  
(Part # NT-AUX-ACT)

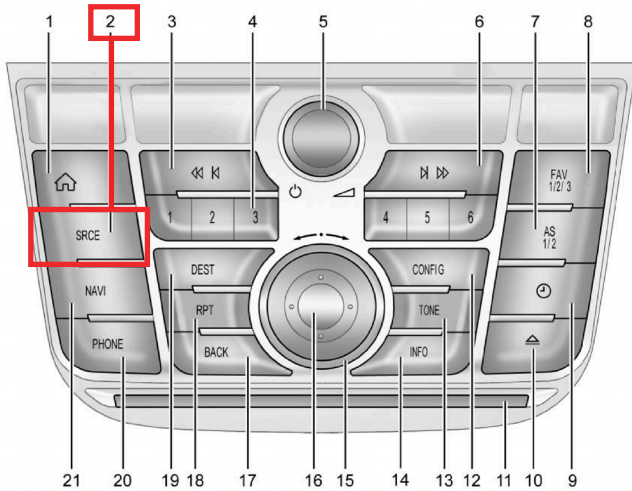

- |                  |                    |
|------------------|--------------------|
| 1. Home          | 4. Presets 1-6     |
| 2. SRCE (Source) | 5. Power/Volume    |
| 3. <<K (Seek Up) | 6. >>K (Seek Down) |

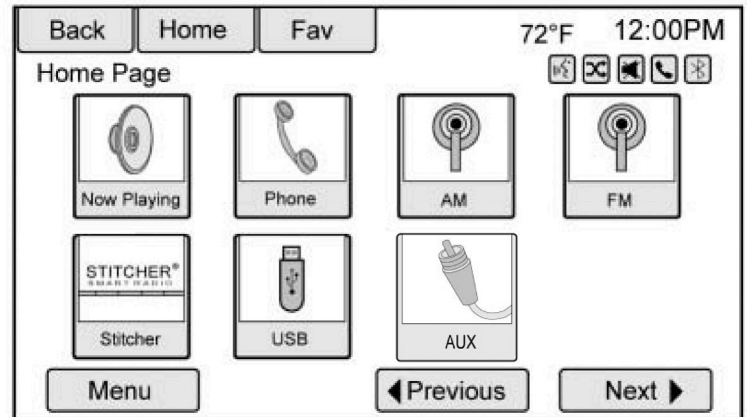

### Set Radio to AUX Audio Input:

- SRCE Button: Press the SRCE button to display the audio screen. Press to switch between AM, FM, or XM, if equipped, Disc, or AUX (Auxiliary). Must set a radio to auxiliary/AUX before activating NavTool to hear audio from car speakers.
- Audio will not play through car speakers if AUX activator jack is not connected or radio is not set to AUX input.

# User Manual

## Quick Operation Guide

Thank you for purchasing NavTool. If you have any questions, please call toll-free at 877-628-8665.

The color/navigation screen will display a factory image when you first start your vehicle.

 **Prior to NavTool installation, if your smartphone is paired to the vehicle bluetooth system for calling, please go into your smartphone bluetooth settings, find your vehicle and do Forget This Device.**

- Set the radio to AUX input to hear the Apple CarPlay/Android Auto audio. Navigation directions, music, and phone calls from the NavTool Apple CarPlay/Android Auto interface will play via AUX input of the radio. See Page 1 for details.

- Press and hold one of the four corners with your thumb for 3 seconds to activate the interface. The preferred corner is the top right. (see Fig.1) You should hear a chirp, and after that, the interface will start, and the NavTool menu will appear on the screen. After activating the interface, the NavTool screen will show. (see Fig.2) Tap Home to access the bottom menu bar. (see Fig. 3) or press and hold one of the corners for 3 seconds with your thumb to bring up the bottom menu.



Fig. 1

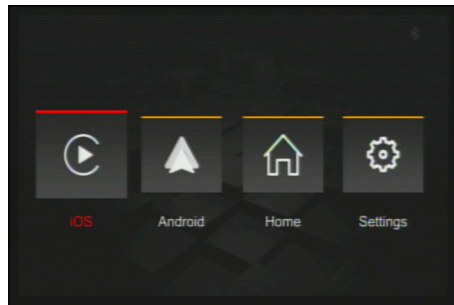

Fig. 2

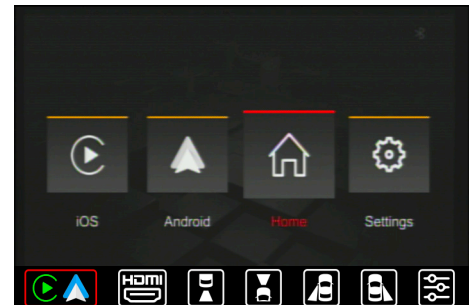
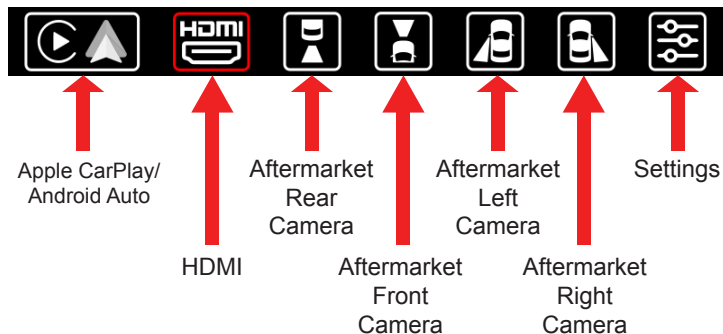

Fig. 3



**How to exit video inputs:** To leave HDMI or any camera inputs, tap anywhere on the touch screen to bring up the bottom menu bar.

**Aftermarket Camera Operation:** The factory rearview camera will continue to work in reverse. If you installed a forward-facing camera, you could manually select it in the menu, or it will automatically display up to 10 miles per hour on the screen. This automation will happen when you put the car into drive after reverse gear. Aftermarket left and right lane watch cameras will work with respective turn signals while driving or can be selected manually via the menu.

**How to Return to Factory Screen:** Press and hold one of the four corners of the touch screen for 3 seconds to turn off NavTool interface. Press and hold the corner of the touch screen for a few seconds until the bottom menu appears on the screen, release the finger and hold the corner of the screen again to return to the factory menu.

# User Manual

## Quick Operation Guide - Pair Additional Phones

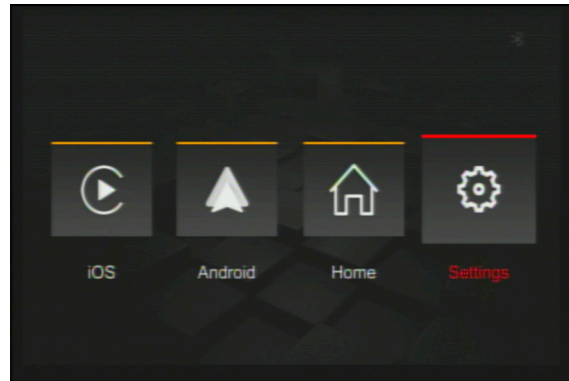

### Apple CarPlay

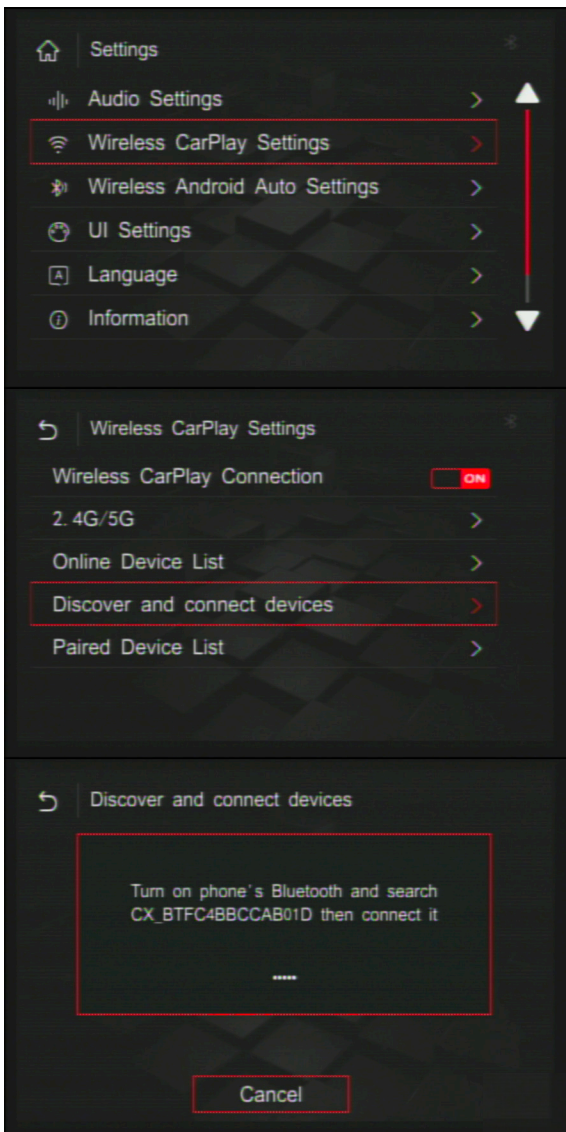

### Android Auto

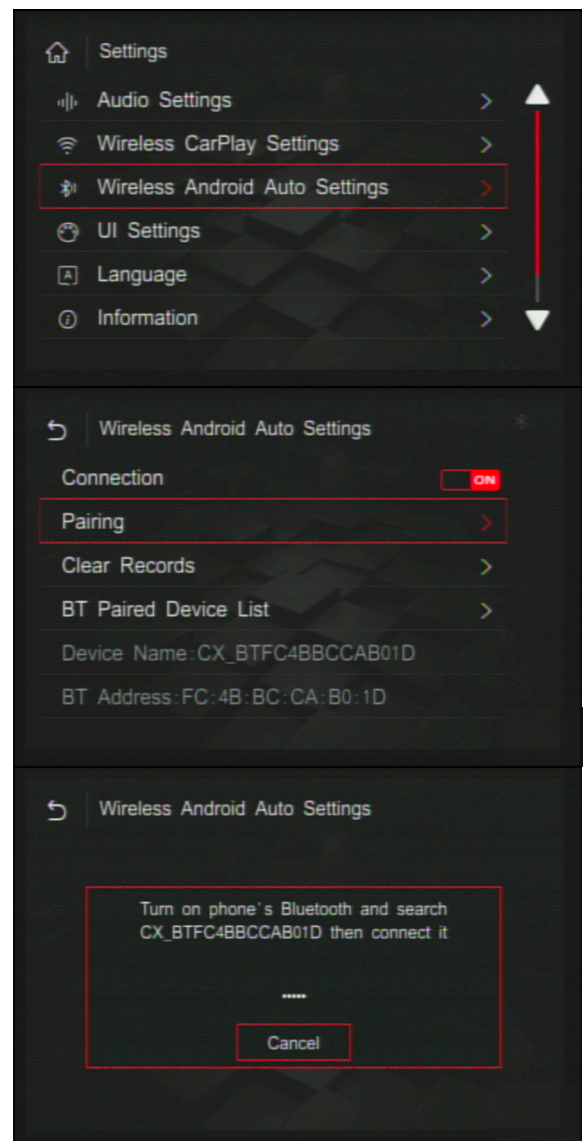

# User Manual

## Interface Settings



### Settings

- Tap the settings menu button
- This will open a menu that will let you change different settings on the interface.



### Interface Settings

- Tap the settings gear icon.
- This will let you change different interface settings.

Set this feature to ON if you want to directly enter into the Apple CarPlay/Android Auto mode when activating the interface, and bypassing the NavTool menu. Do not select this mode if you plan to use HDMI input or if you want to view other video inputs.

Set this feature to OFF if you want to enter NavTool menu upon activation of the interface.

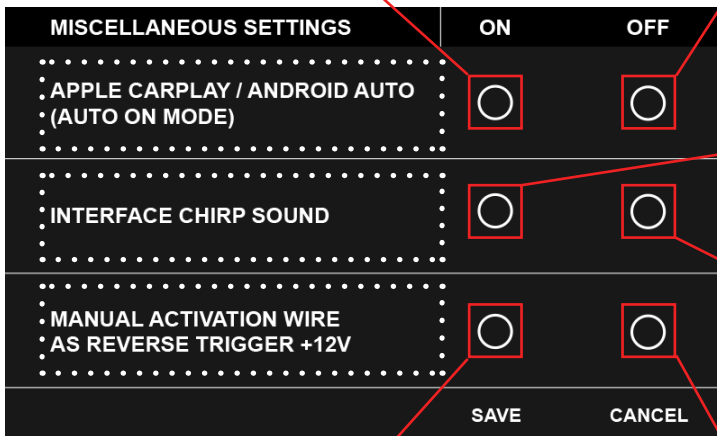

Turn this feature to ON to enable audio feedback from the interface when activating the interface or when smartphone wireless connection is established.

Turn this feature to OFF if audio feedback from the interface is not required.

Turn ON manual activation wire as reverse trigger if your manual tells you to or if done by an installer. Do not change if installer has set this feature to ON.

Turn OFF: Most vehicles will have manual activation wire turned off. Do not change if installer has set this feature to OFF.

- Tap the text of the setting you want to change. This will turn the setting ON or OFF.
- SAVE or CANCEL your changes.



### Parking Line Settings

Typically adjusted by installer.



### Camera Settings

Typically adjusted by installer.

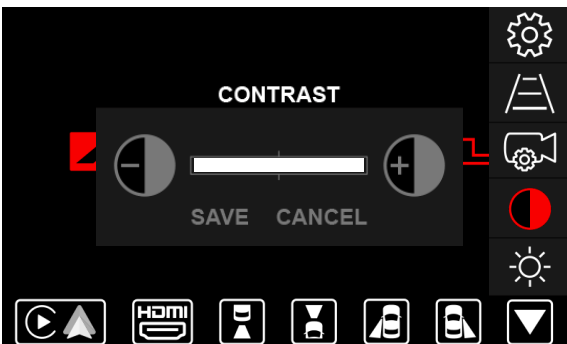

### Contrast

Tap the Contrast button to enter this option.

After selecting contrast, you can adjust the contrast of the interface. The white bar in the middle shows the interface contrast setting. You can lower the contrast of the interface by tapping the minus on the left and increase the interface's contrast by tapping the plus on the right. Save or cancel any changes you have made.

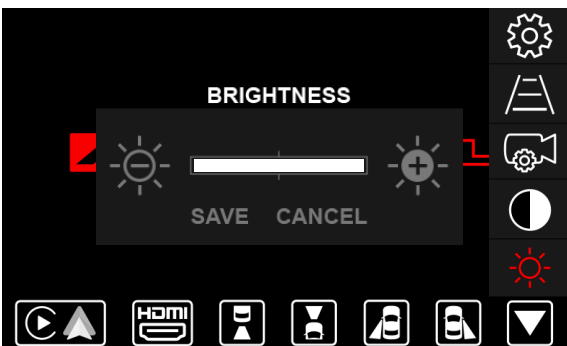

### Brightness

Tap the Brightness button to enter this option.

After selecting brightness, you can adjust the brightness of the interface. The white bar in the middle shows the interface brightness setting. You can lower the brightness of the interface by tapping the minus on the left and increase the interface's brightness by tapping the plus on the right. Save or cancel any changes you have made.



# User Manual

## Apple CarPlay/Android Auto Connection and Operation

**Step 1:** Activate the interface (See page 2 for details).

**Step 2:** Select Apple CarPlay or Android Auto in the menu. (See Fig.3 on page 3 for details)

**Step 3:** Enter bluetooth settings on your smartphone and pair your phone to the bluetooth device shown on your car screen (See Fig.4)

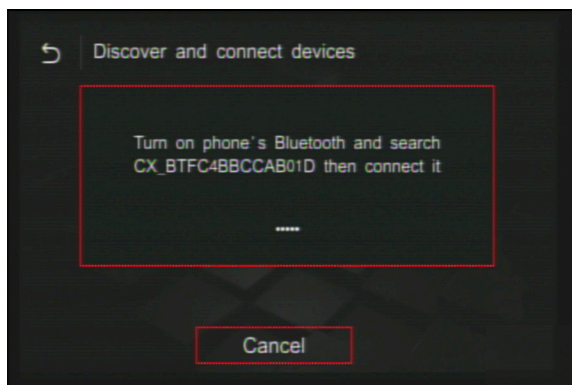

Fig. 4

**Step 4:** Apple CarPlay or Android Auto will appear on the screen. (See Fig.5 and Fig.6)

### Apple CarPlay/Android Auto enter and exit (To change automatic or standard mode, see page 4)

**Auto Mode ON:** Suppose automatic Apple CarPlay/Android Auto mode is activated. When you press and hold the corner of the touch screen, you will automatically enter Apple CarPlay/Android Auto mode bypassing the NavTool menu. You can automatically get out of the Apple CarPlay mode by going to the Main Menu App inside the Apple CarPlay. (See Fig.5) Or you can get out of Android Auto mode by going to the Exit App inside Android Auto. (See Fig.6)

**Standard Mode (Auto Mode OFF):** Suppose automatic Apple CarPlay/Android Auto mode is set to OFF. You can get out of the Apple CarPlay mode by going to the Main Menu App inside the Apple CarPlay. (See Fig.5) Or you can get out of Android Auto mode by going to the Exit App inside Android Auto. (See Fig.6) This action will bring you to the NavTool interface main menu.

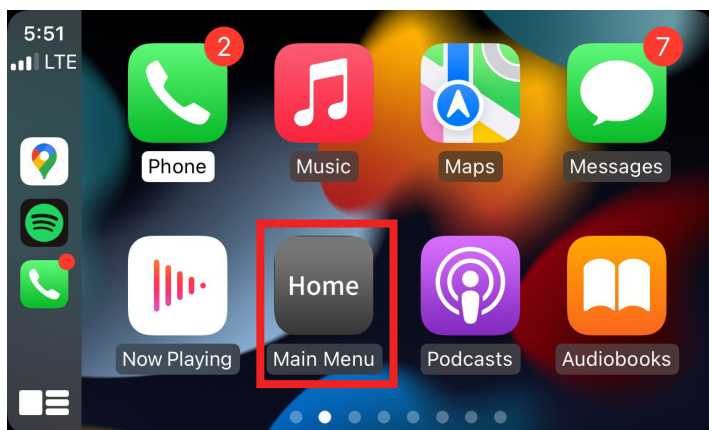

Fig. 5

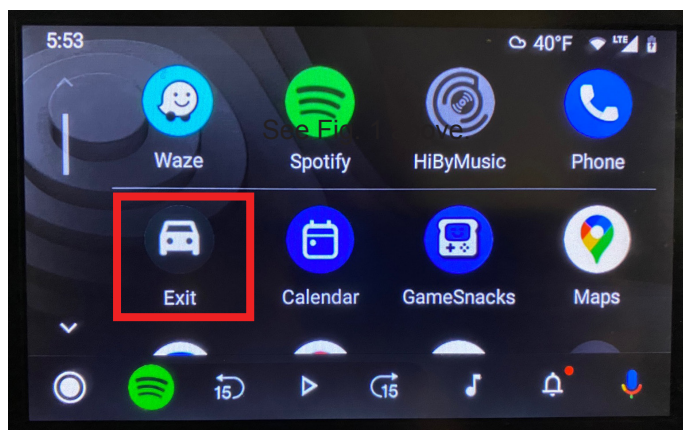
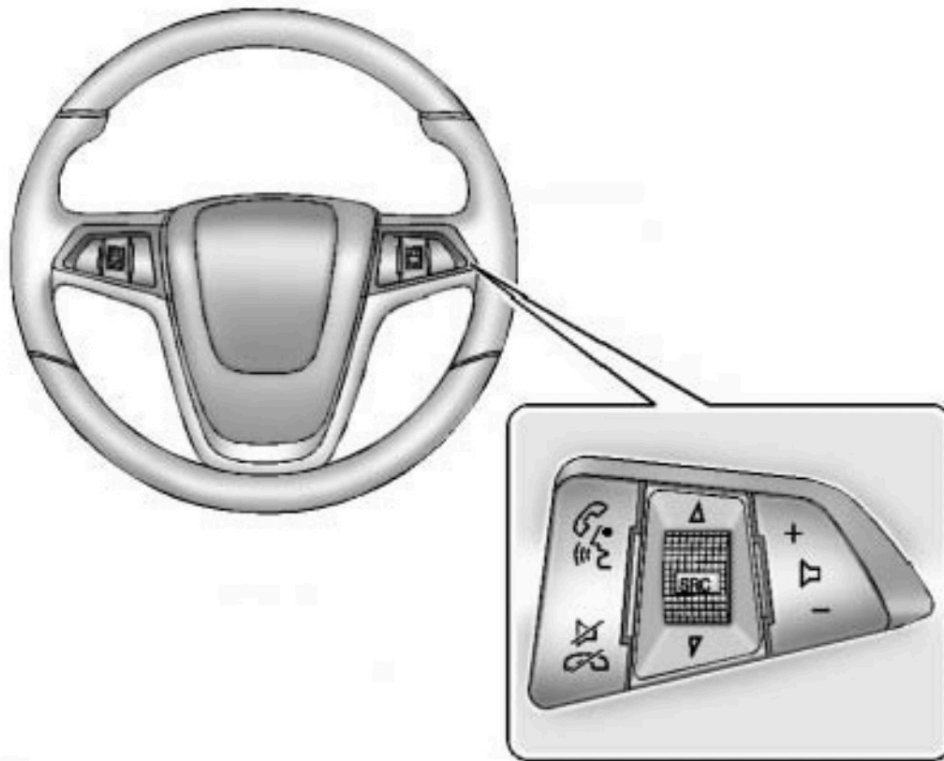

Fig. 6

# User Manual

## Audio Steering Wheel Controls



Steering wheel buttons can be used with Apple CarPlay/Android Auto, when interface is activated buttons are repurposed for the interface use.



**Up: Press to go to the next track**



**Down: Press to go to the previous track**

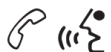

**Phone/Voice: Press to activate Siri or Ok Google, or press to answer a call**



**Mute/Hang Up: Press to hang up or decline a call**



**Volume: Press to increase or decrease the volume**