

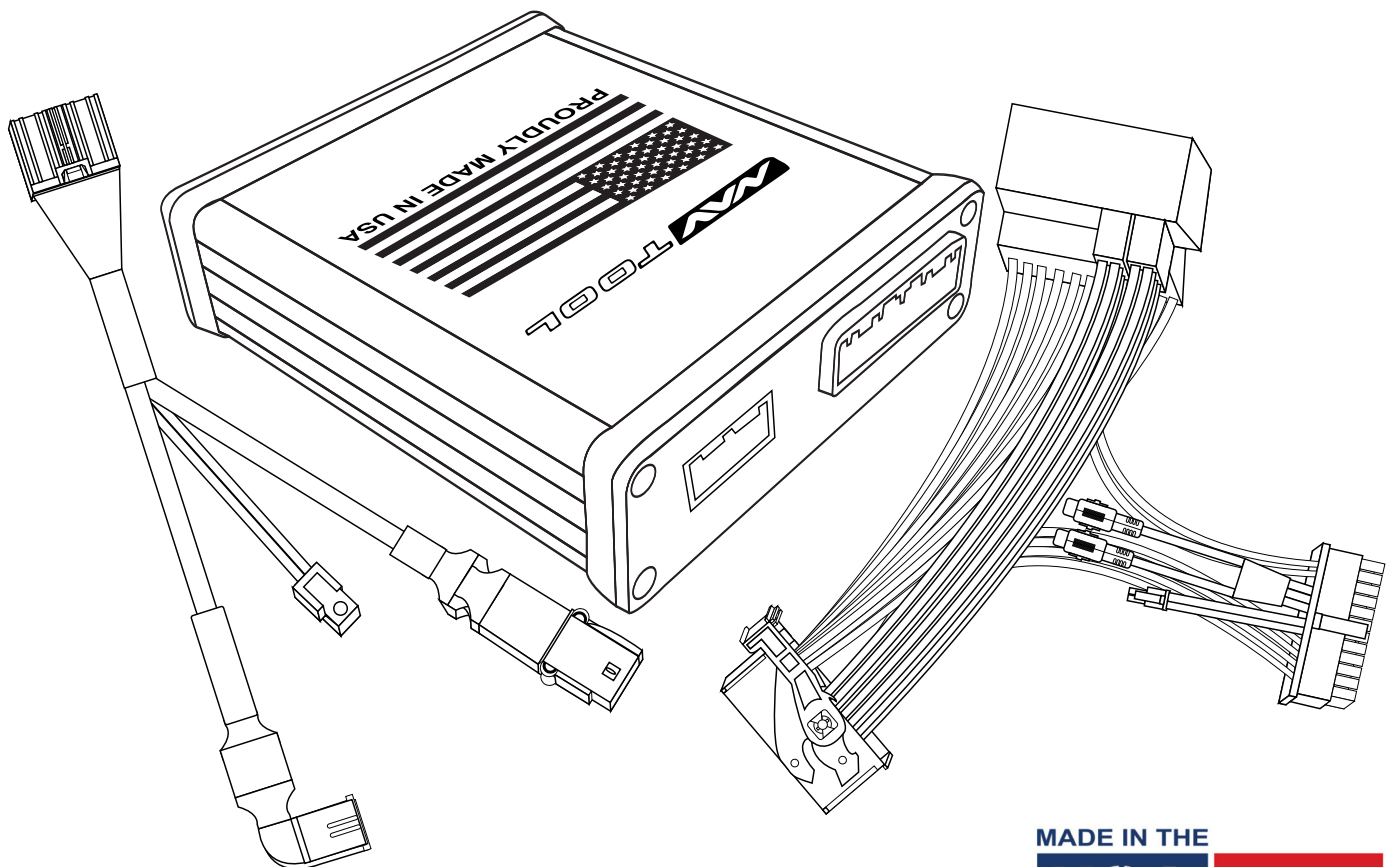

Installation Manual

BMW 5 Series 2004-2009



Interface with HDMI

Part #: NAVTOOL6.0-LB0-HDMI

*NOTICE: Navtool recommends having this installation performed by a certified technician.
Logos and trademarks used here in are the properties of their respective owners.*



BMW 5 Series 2004-2009

WELCOME

IMPORTANT WARNING

This product includes instructions for installation, which must be carefully followed. The instructions are worded in such a manner to assume that the installer is capable of completing these types of electronic installations. Suppose you are unclear about what you are instructed to do or believe you do not understand the instructions to complete the installation properly and safely. In that case, you should consult a technician who has this knowledge and understanding. Failure to follow these instructions carefully and install the interface as described could cause harm to the vehicle or safety systems on the vehicle. Interference with specific safety systems could cause damage to persons as well.



NEED HELP?



Open the camera app on your smartphone and point your rear camera at the QR-Code to scan it. Finally, tap the pop up banner to open support website.

Table of Contents

Installation Instructions

Precautions	3
What's In The Box	4
Interface Connectors Description	5
Universal Harness Description	6
Quick Connection Guide	7-9
Installation Instructions	10-18
Testing and Settings	19-22

Extra Details

Vehicle Reassembly Checklist	23
Connect Rear Screens With AV Input	24
Connect Rear Screens With HDMI Input	25

User Manual

User Manual for Consumers	C1-C3
---	-------

Print pages C1-C3 and give them to the customer

Precautions

PLEASE READ BEFORE YOU START THE INSTALLATION

- Please study these instructions carefully before installing NavTool interface.
- Many new vehicles use low-voltage or data-bus systems that can be damaged by test lights and logic probes. Test all circuits with a digital multi-meter before making connections.
- Do not disconnect the battery if the vehicle has an anti-theft-coded radio, unless you have the radio code.
- If installing an external push button switch, check with the customer about where to install the switch.
- To avoid accidental battery drainage turn off the interior lights or remove the dome light fuse.
- Roll down a window to avoid being locked out of the car.
- Use of this product in a manner different to its intended way of operation may result in property damage, personal injury, or death.
- Set Parking brake.
- Remove the negative battery cable.
- Protect fenders before starting.
- Using protective blankets to cover front seats, interior of the vehicle and center console.
- Always install a fuse 6-12 inches away from NavTool interface, 5 amp fuse should be used.
- Always secure NavTool interface with Velcro or double side tape to prevent rattling of the interface.
- When securing NavTool interface make sure that panels can be closed back easily.
- Use electrical tape on all you connections and splices, do not leave any exposed connections.
- Route all wires along factory harnesses, try not to drill or make any unnecessary holes.
- Make sure you are not connecting to any data wires; always check your connections with a multi-meter.
- Always use help of a professional installer to prevent any damage to the vehicle or NavTool interface.

What's In The Box?

NavTool Interface
(Part # NAVTOOL6.0-LB0-NBT)

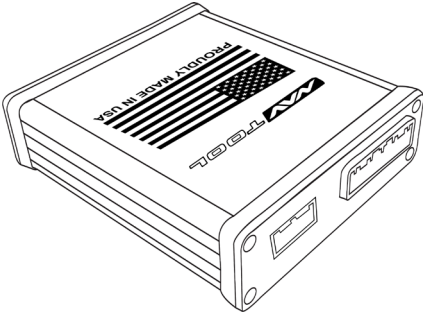

Vehicle Specific
Plug and Play Harness
(Part # NT-QUADLOCK-V1)

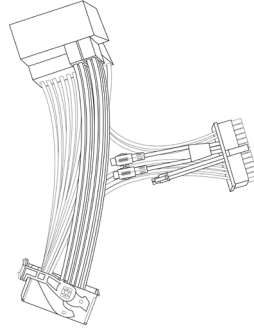

NavTool Interface
(Part # NAVTOOL-BMWRLY)

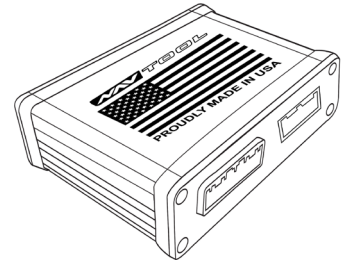

NavTool Interface Harness
(Part # NT-WHNT6)

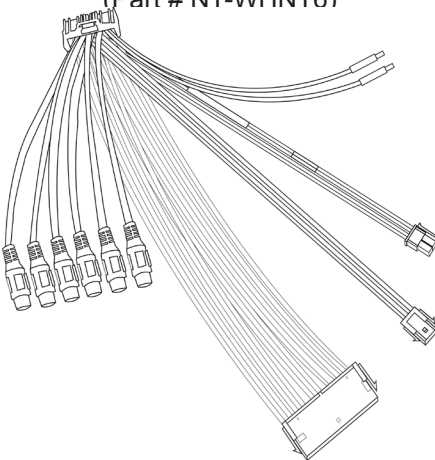

Vehicle Specific
Plug and Play Harness
(Part # NT-BMWDRV)

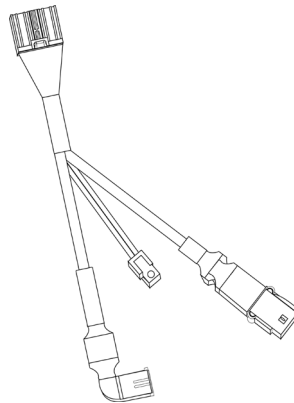

NavTool Interconnect Cable
(Part # NT-EXT-BOX)

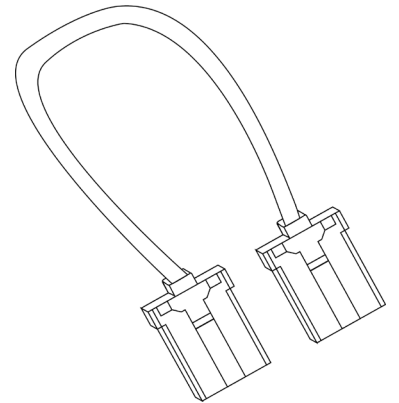

USB Configuration Cable
(Part # NT-USB-CNG)

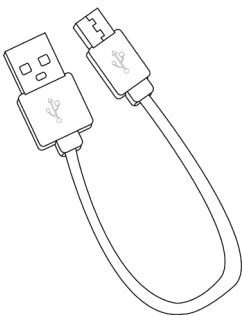

AUX Cable
(Part # NT-AUX-35)

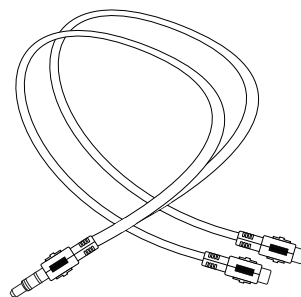

Interface Connectors Description

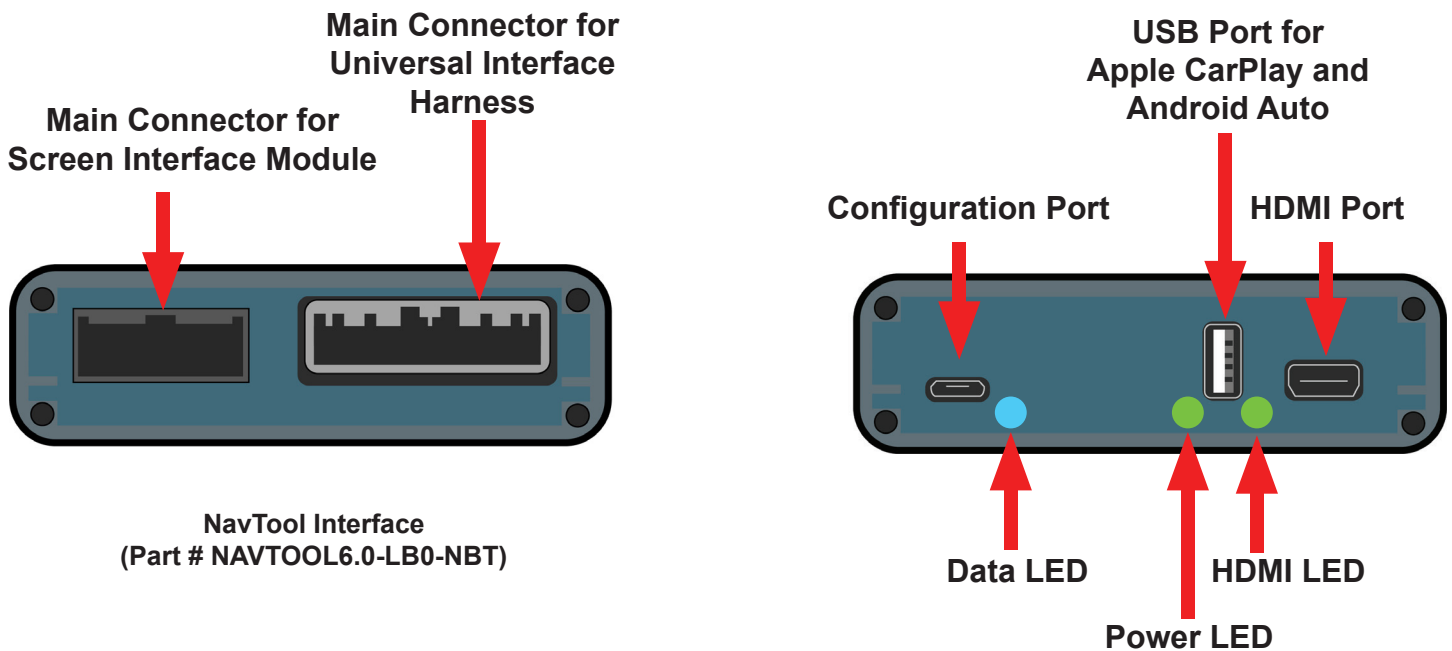

Main Connector for Universal Interface Harness- This port is dedicated for a connection of a universal wiring harness.

Main Connector for Screen Interface Module- This port is dedicated for a connection of a screen interface module.

Configuration Port- This USB port is dedicated for the interface configuration only.

Data LED- Normal operation of the interface must have blue LED blinking. If the blue LED is not blinking, the interface is not receiving data from the vehicle. If the blue LED is not blinking, the interface will not operate properly.

Power LED- Normal operation of the interface must have a green LED ON. If the green LED is not ON, the interface is not receiving power. If the green LED is not ON, the interface will not work, and your vehicle radio may also stay OFF.

HDMI LED- Normal operation of the interface must have a green LED ON. If the green LED is not ON, the interface HDMI is not receiving power. If the green LED is not ON, the interface HDMI port will not work.

USB Port for Apple CarPlay and Android Auto- This USB port is for hard-wire connection of a smartphone if you want your iPhone or Android hard-wired to the interface instead of a wireless connection. This USB port also provides charging for your smartphone. This connection is not required if you plan to use Apple CarPlay and Android Auto via the wireless connection. Do not use this USB port to power up HDMI streaming devices such as Roku, FireStick, Chromecast, or similar devices.

HDMI Port- HDMI port is dedicated for connecting video sources such as iPhone mirroring, Android Mirroring, Apple TV, Roku, FireStick, Chromecast, PlayStation, Xbox, or similar devices.

Universal Harness Description

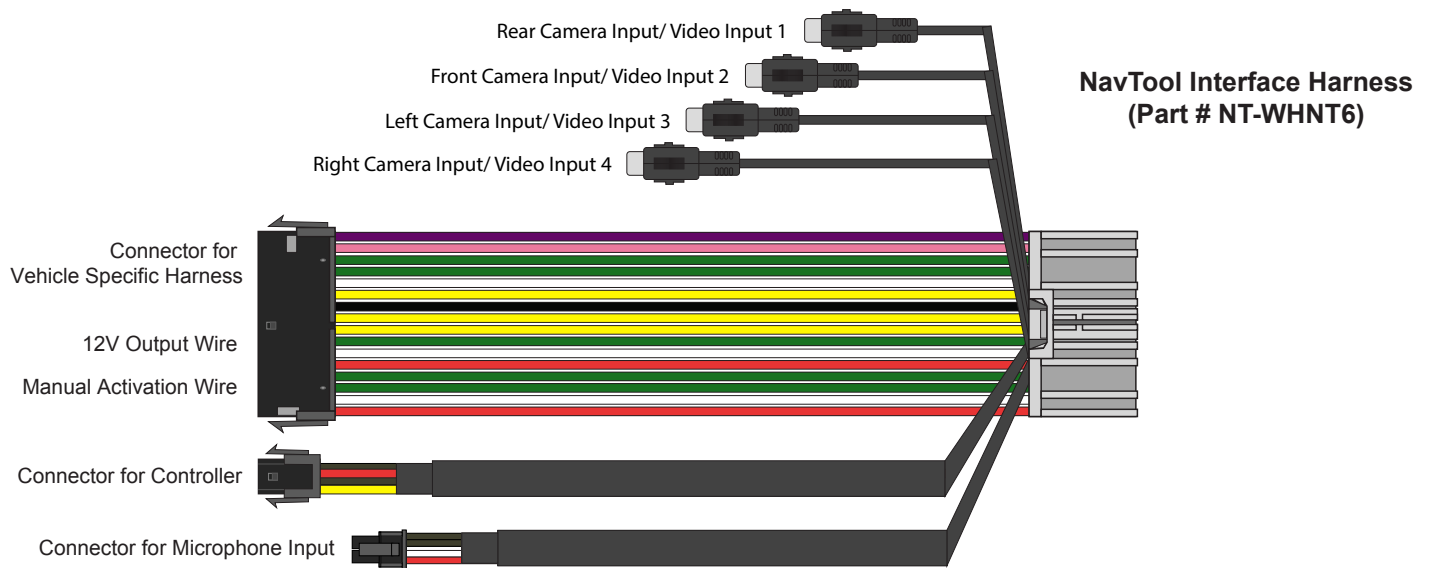

Rear Camera Input /Video Input 1- This input is dedicated for an aftermarket rearview camera or a video source with an RCA video output. Your vehicle factory camera will continue to work as before without any changes.

Front Camera Input /Video Input 2- This input is dedicated for an aftermarket front view camera or a video source with an RCA video output. Your vehicle factory camera will continue to work as before without any changes.

Left Camera Input / Video Input 3- This input is dedicated for an aftermarket left view camera or a video source with an RCA video output. Your vehicle factory camera will continue to work as before without any changes.

Right Camera Input / Video Input 4- This input is dedicated for an aftermarket right view camera or a video source with an RCA video output. Your vehicle factory camera will continue to work as before without any changes.

Connector for Vehicle Specific Harness- This connection is dedicated for connecting vehicle specific plug and play wiring harness.

Connector to Controller- Not Used

Connector for Microphone Input- This connection is dedicated for connecting a built-in vehicle microphone. See the quick connection guide on page 7 of this manual.

+12V Manual Activation Input- This connection is used only if the factory rearview camera is not operating correctly in reverse. In that case, this wire must be connected to the vehicle's reverse +12V output. (Change setting "Manual Activation Wire as +12V Reverse Input" See page 41)

+12V Output- 500 mA output can be used to drive a relay. This output provides +12V at all times when the vehicle is running.

Quick Connection Guide

See Page 8

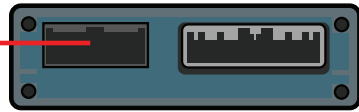

NavTool Interface
(Part # NAVTOOL6.0-LB0-NBT)

Click

NavTool Supplied Harness
(Part # NT-WHNT6)

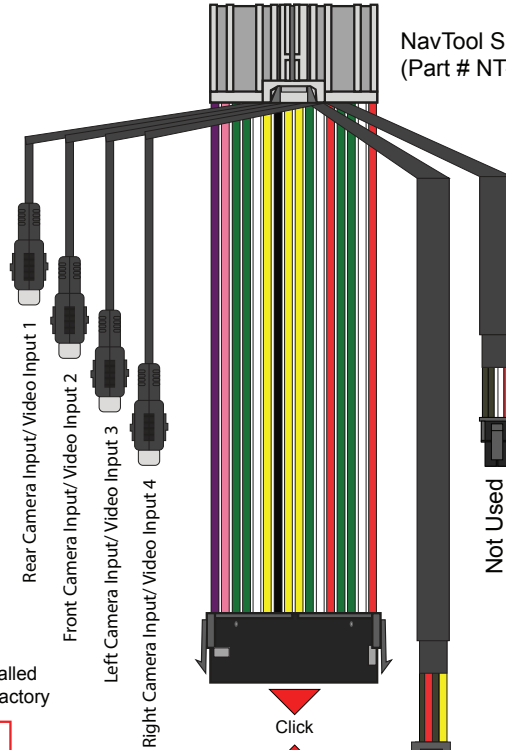

AUX Input jack installed
in your car from the factory



Click

Not Used

See Page 8

Click



Back of Car Radio

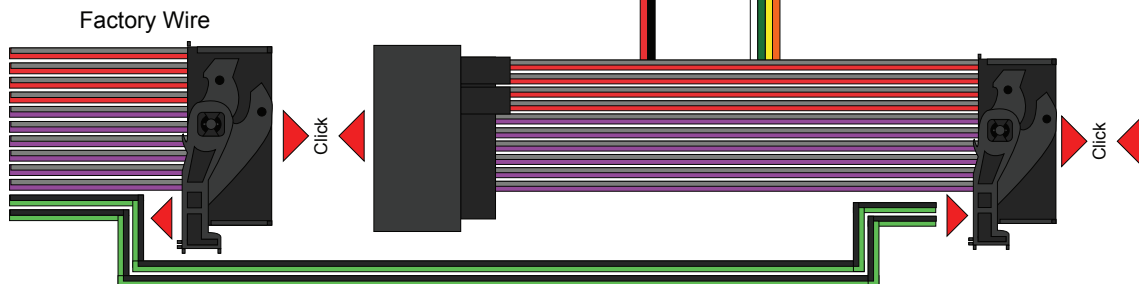

Remove Fiber Optic Cable from the factory plug and insert into the supplied plug and play harness (See Page 9)

Quick Connection Guide 2

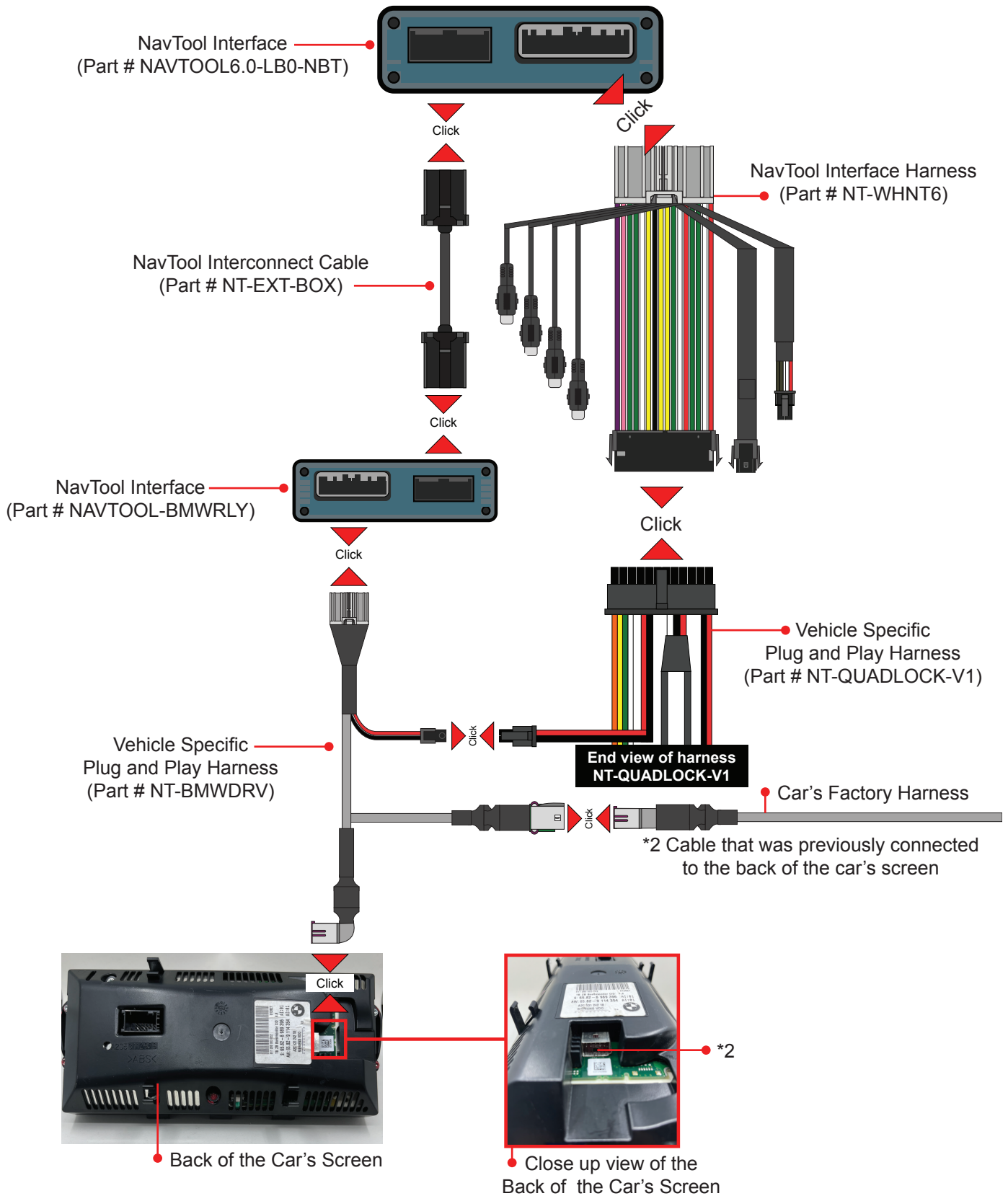

Quick Connection Guide 3

How to Relocate Fiber Optic Cable

Vehicle Factory Harness

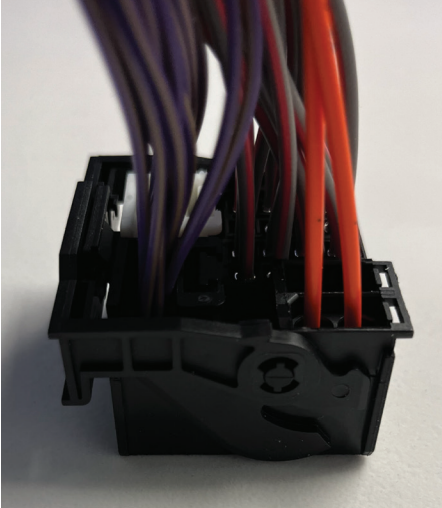

Vehicle factory harness with fiber optic cable inserted

(Fiber optic cable and wire colors shown above are for reference purposes only, actual vehicle harness colors may differ.)

Vehicle Factory Harness

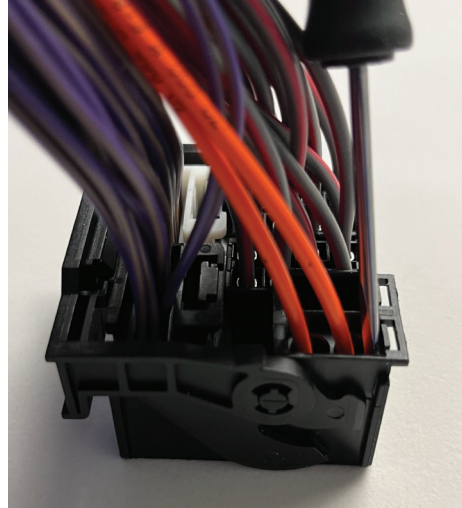

Insert small screwdriver or a pick tool between the lock and the fiber optic assembly plug.

Vehicle Factory Harness

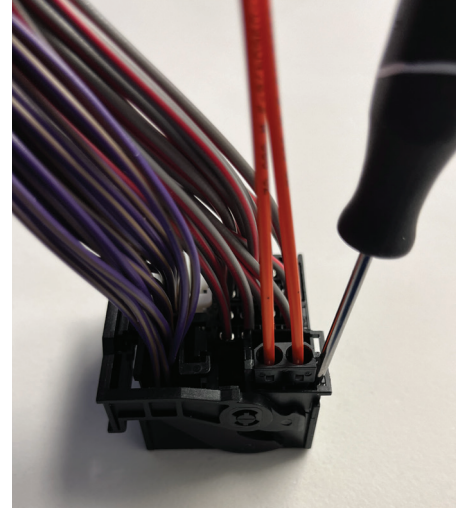

Gently pull the fiber optic plug out.

Vehicle Factory Harness

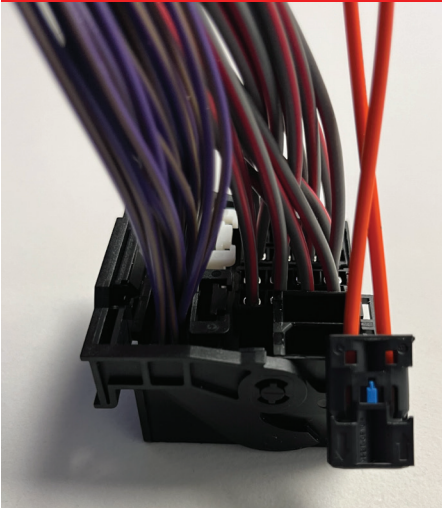
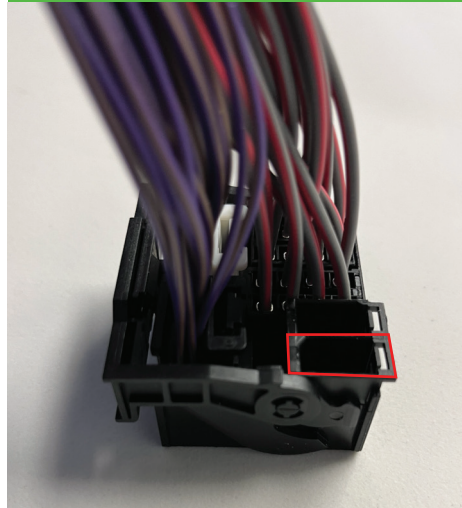

Image above is the fiber optic assembly removed from the vehicle's factory harness.

NavTool Supplied Harness



Take the NavTool supplied harness with out the inserted fiber optic assembly.

NavTool Supplied Harness

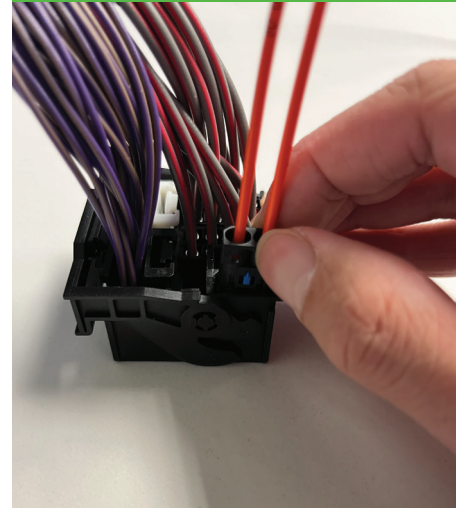

Insert the fiber optic plug into the same position on the NavTool supplied harness.

Installation Instructions

STEP 1

NO APPLICATION OR SOFTWARE DOWNLOAD IS REQUIRED TO CONFIGURE THE INTERFACE.

To configure the interface, you must use Windows, Mac, or Google computer.

Windows computers must use the latest version of Google Chrome or Microsoft Edge browser.

Mac computers must use the latest version of the Google Chrome browser.

Google computers must use the latest version of the Google Chrome browser.

TO CONFIGURE THE INTERFACE, GO TO [HTTPS://CONFIG.NAVTOOL.COM](https://config.navtool.com)

Connect the interface to the computer using supplied USB Configuration Cable (Part # NT-USB-CNG)

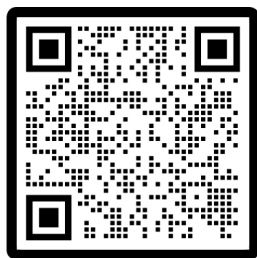
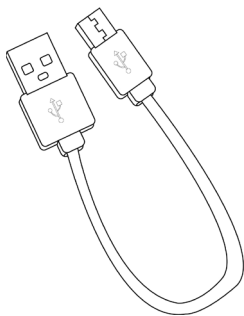

SCAN ME

To see a video of the configuration process
Scan QR-Code or go to
https://youtu.be/iES_rW240X0

STEP 2

Remove Vehicle Navigation Radio or Color Screen

List of Required Tools:

1. Plastic Panel Removal Tool- Example of a removal tool is shown below. Any similar removal tool will do the job. It does not need to be the same as the picture below.
2. T20 Torx Bit- On a drill or by manually by hand.
3. Phillips Head Bit- On a drill or manually by hand.

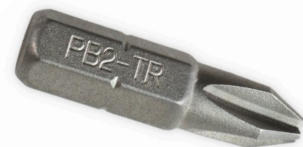

Installation Instructions

STEP 2 Continued

Step 1:

- Remove screw (1).



Step 2:

- Pop out decorative strip (2) at retaining points (1) starting from outside with panel popper
- If necessary, disconnect associated plug connection and remove decorative strip (2).

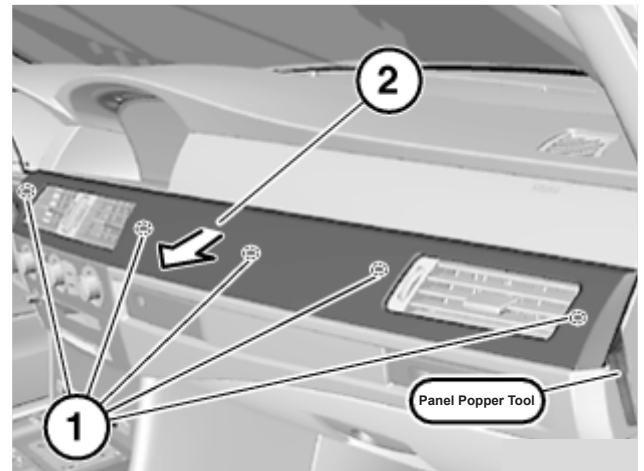

Step 3:

- Remove screws (1).
- Unclip trim (2) from retainers (3) with panel popper tool
- Disconnect associated plug connections and remove trim (4).

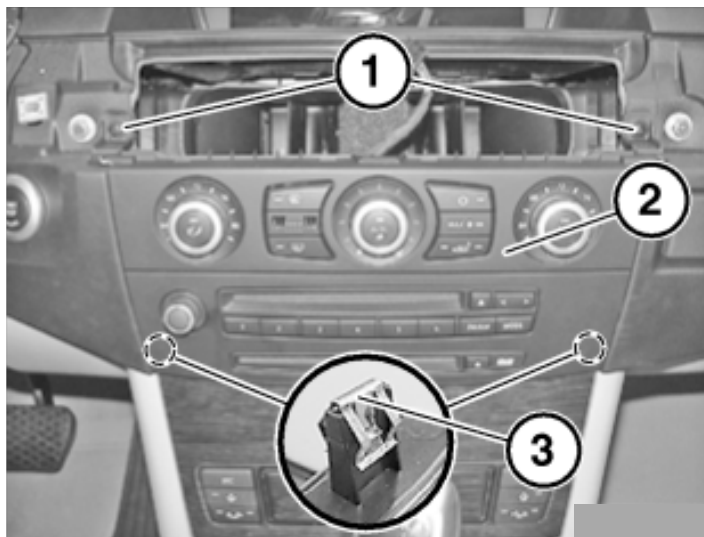

Step 4:

- Open ashtray.
- Release trim (1) at catches (2) towards inside.
- Feed out trim (1) in upward direction.

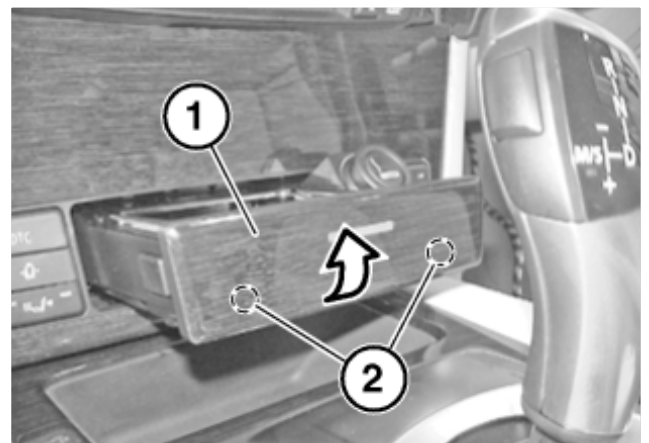

Installation Instructions

STEP 2 Continued

Step 5:

- Release trim (1) with panel popper tool, first at top from retainers (2), then at bottom from pins (3).
- Disconnect associated plug connections and remove trim (1).

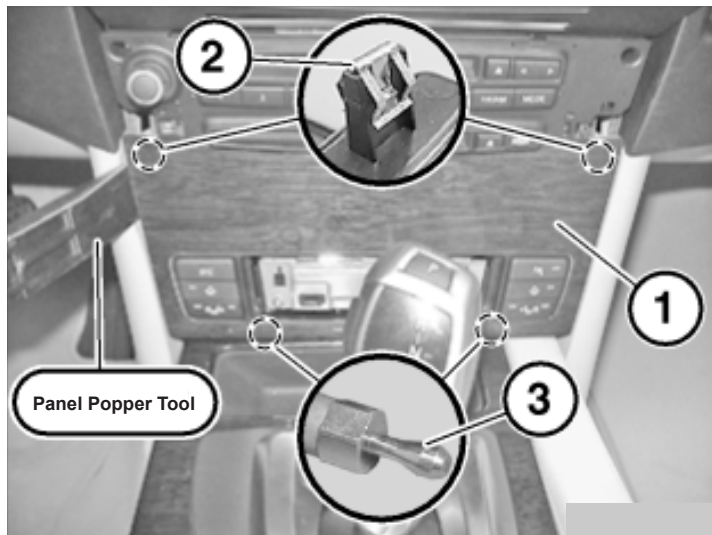

Step 6:

- Remove screws (1).
- Pull CIC (2) out.

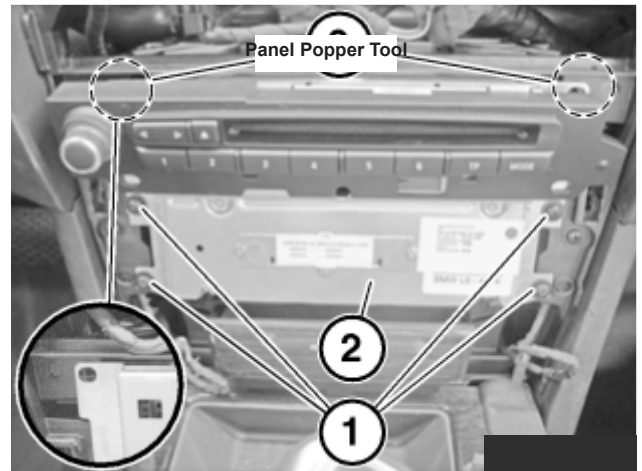

Step 7:

- Unlock plug connections (2) and (3) and disconnect.
- Remove CIC (1).
- Disconnect associated plug connections and remove trim (4).

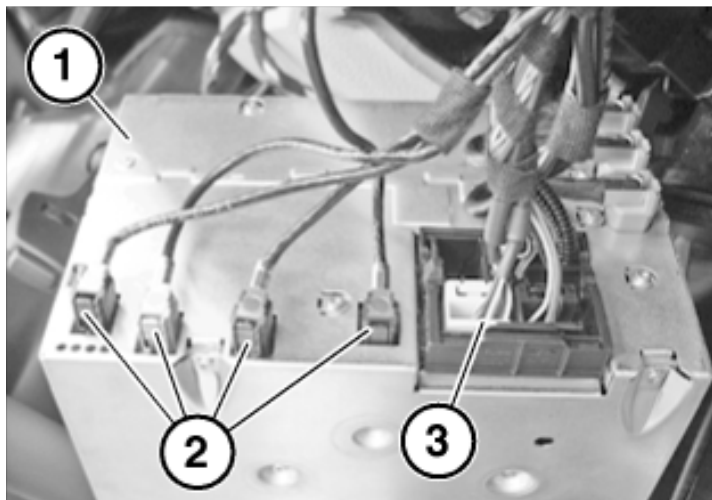

Installation Instructions

STEP 3

Step 1: Unplug Factory Harness from the back of the Radio.

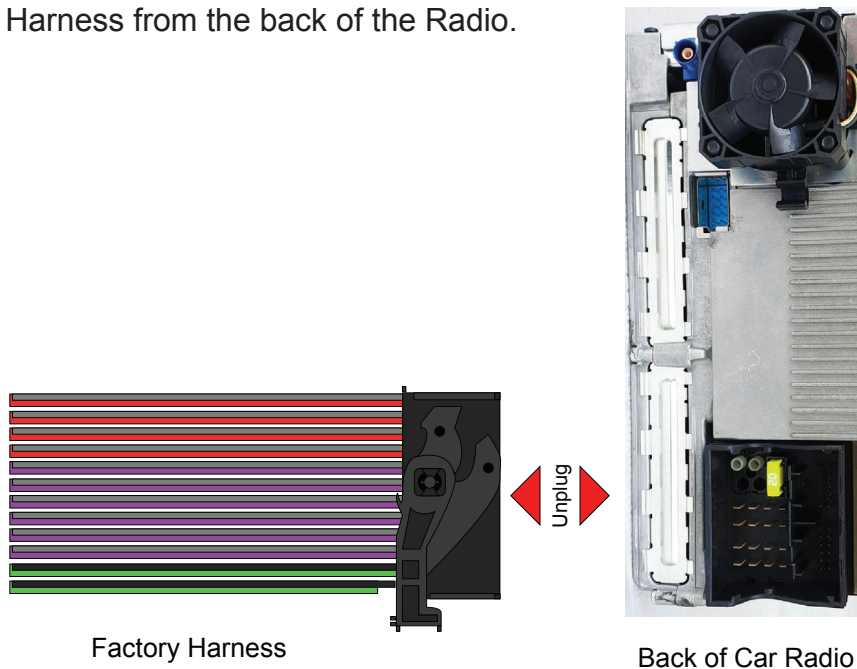

STEP 4

Step 1: Remove the Fiber Optic Cable from the factory plug and insert it into the supplied plug and play harness. (See page 9)

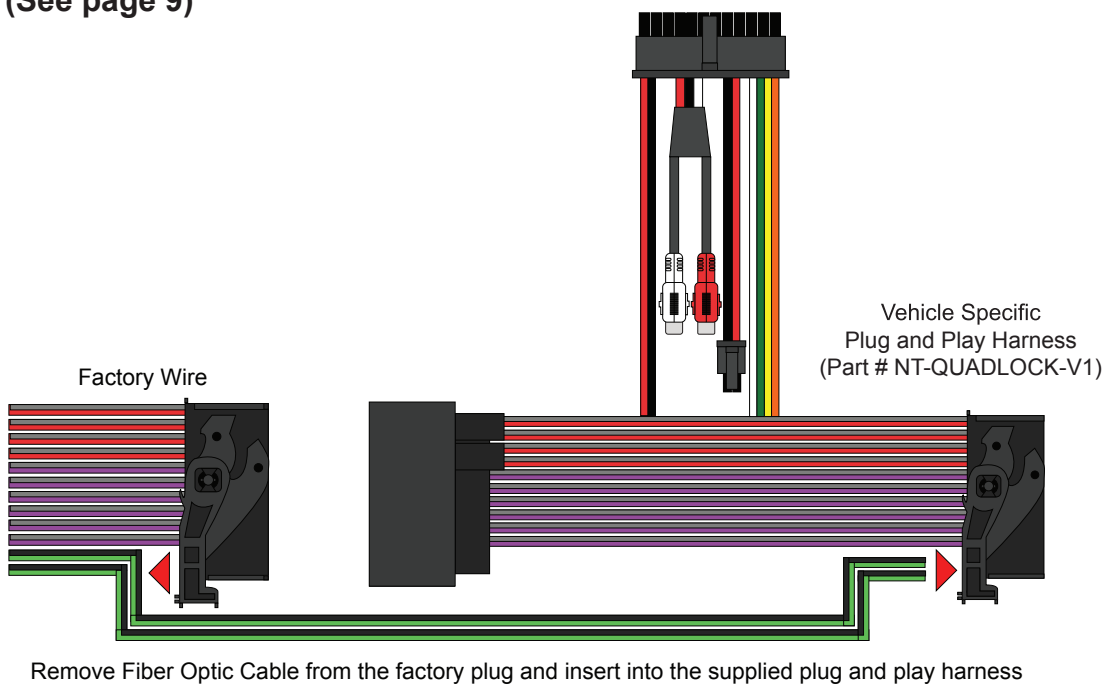

Installation Instructions

STEP 5

Step 1: Connect supplied plug and play harness (Part # NT-QUADLOCK-V1) into the back of the radio.

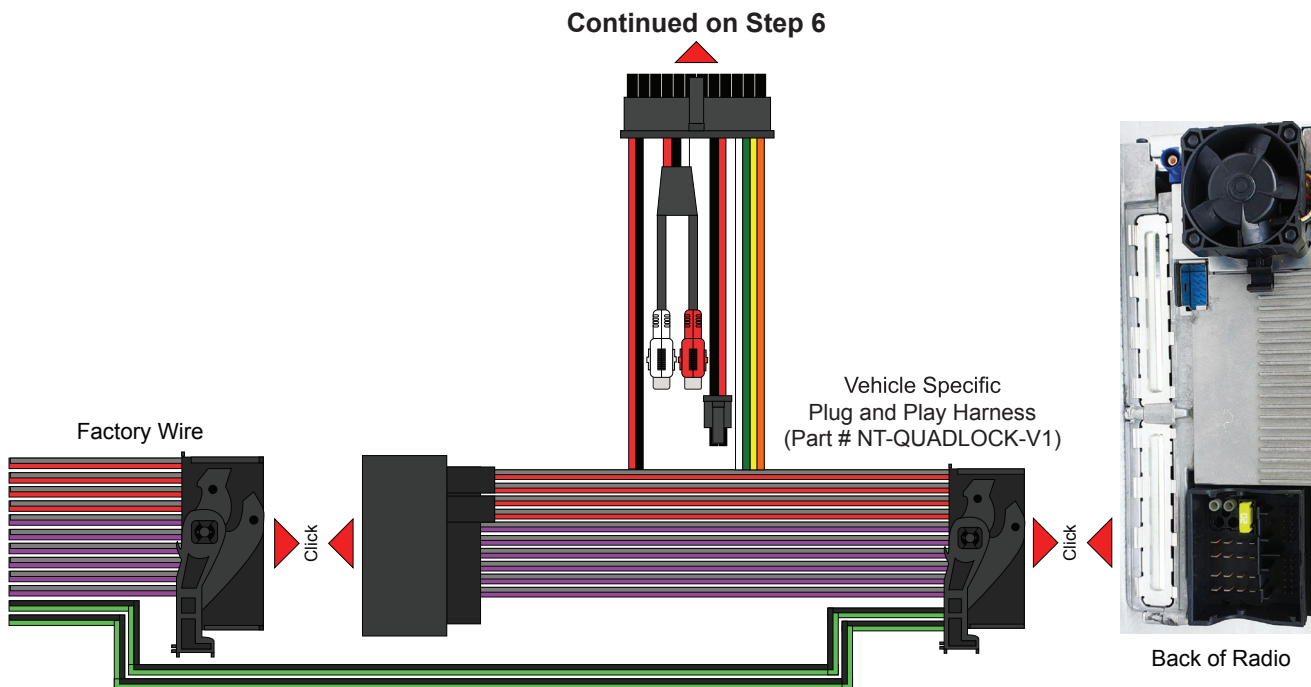

 (For complete image, see Quick Connection Guide on page 7)

Step 2:  Reconnect previously removed radio connectors into the back of the radio.

STEP 6

Step 1: Connect supplied universal wiring harness (Part # NT-WHNT6) into plug and play harness (Part # NT-QUADLOCK-V1).

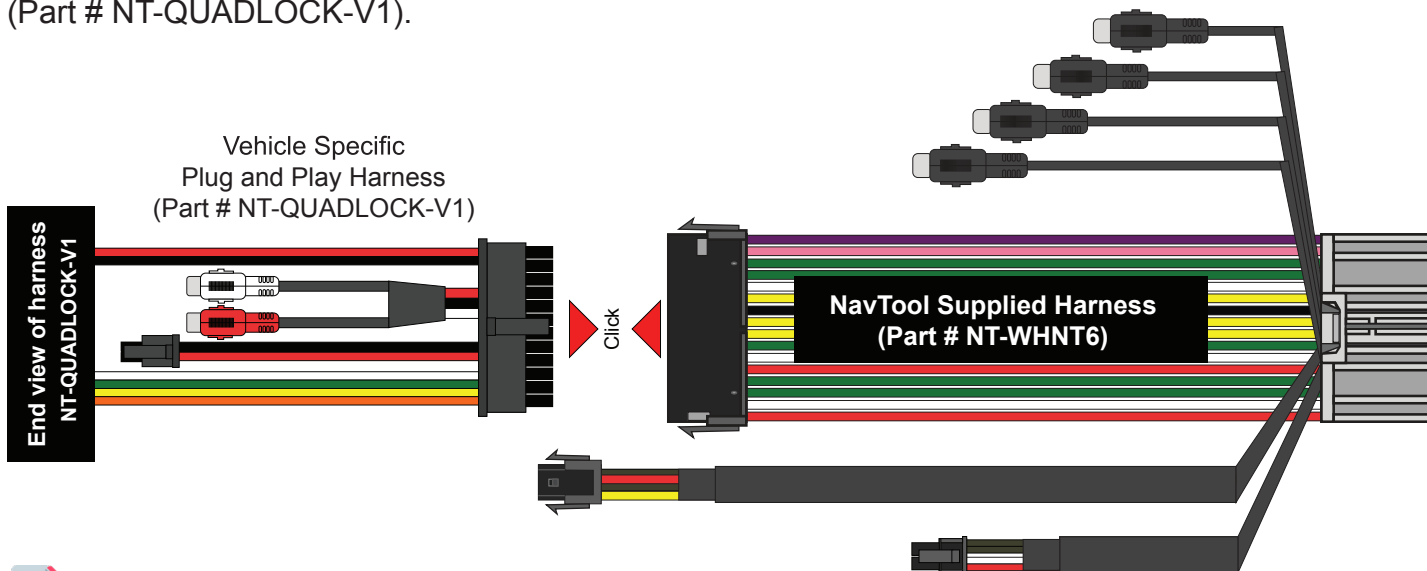

 (For complete image, see Quick Connection Guide on page 7)

Installation Instructions

STEP 7

Step 1: Unplug the factory cable from the back of the vehicle's screen.

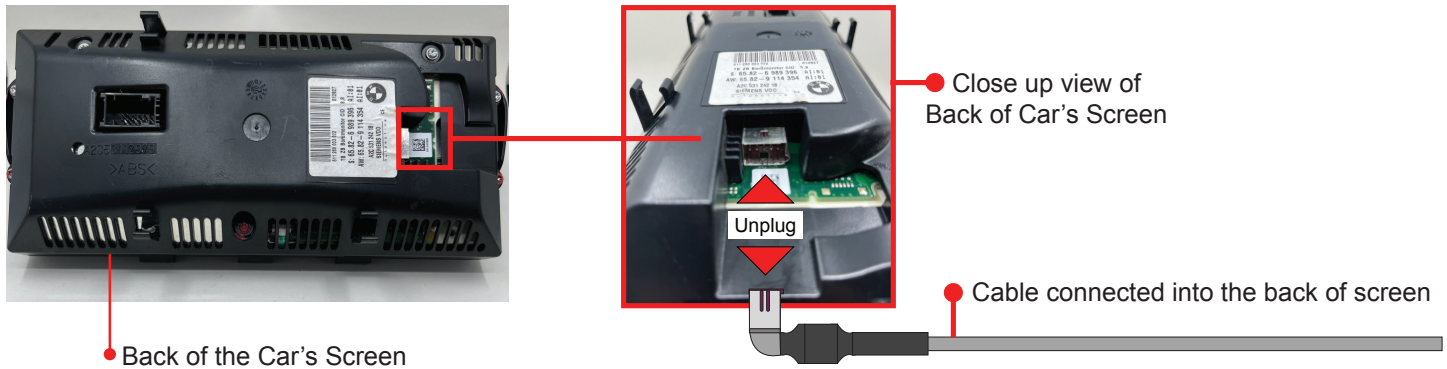



 (For complete image, see Quick Connection Guide on page 8)

STEP 8

Step 1: Plug-in Vehicle Specific Plug and Play Harness (Part # NT-QUADLOCK-V1) into the Vehicle Specific Plug and Play Harness (Part # NT-BMWDRV).

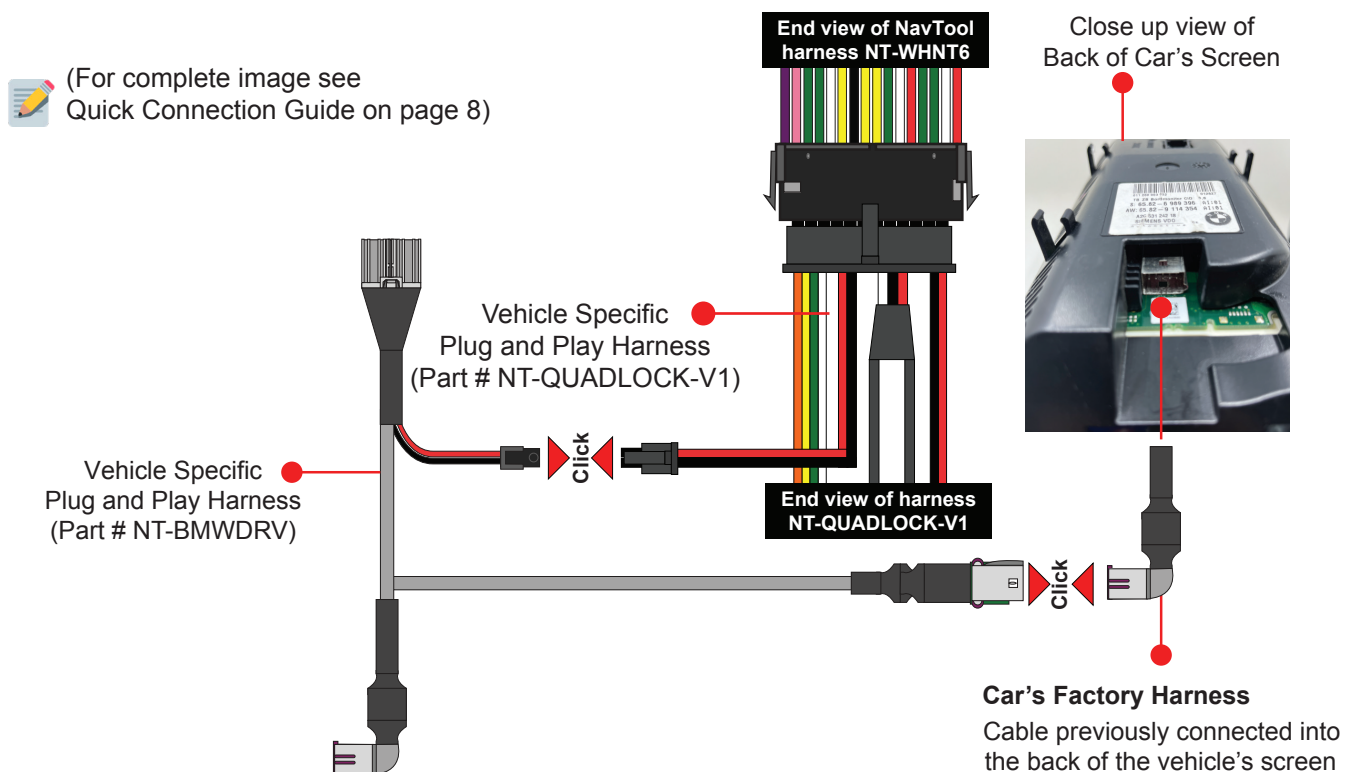
Step 2: Connect the cable previously connected to the back of the vehicle's screen into Vehicle Specific Plug and Play Harness (Part # NT-BMWDRV).



 (For complete image see Quick Connection Guide on page 8)

Installation Instructions

STEP 9

Step 1: Plug-in Vehicle Specific Plug and Play Harness (Part # NT-BMWDRV) into the back of the vehicle's screen.

Step 2: Plug-in Vehicle Specific Plug and Play Harness (Part # NT-BMWDRV) into NavTool Interface (Part # NAVTOOL-BMWRLY).

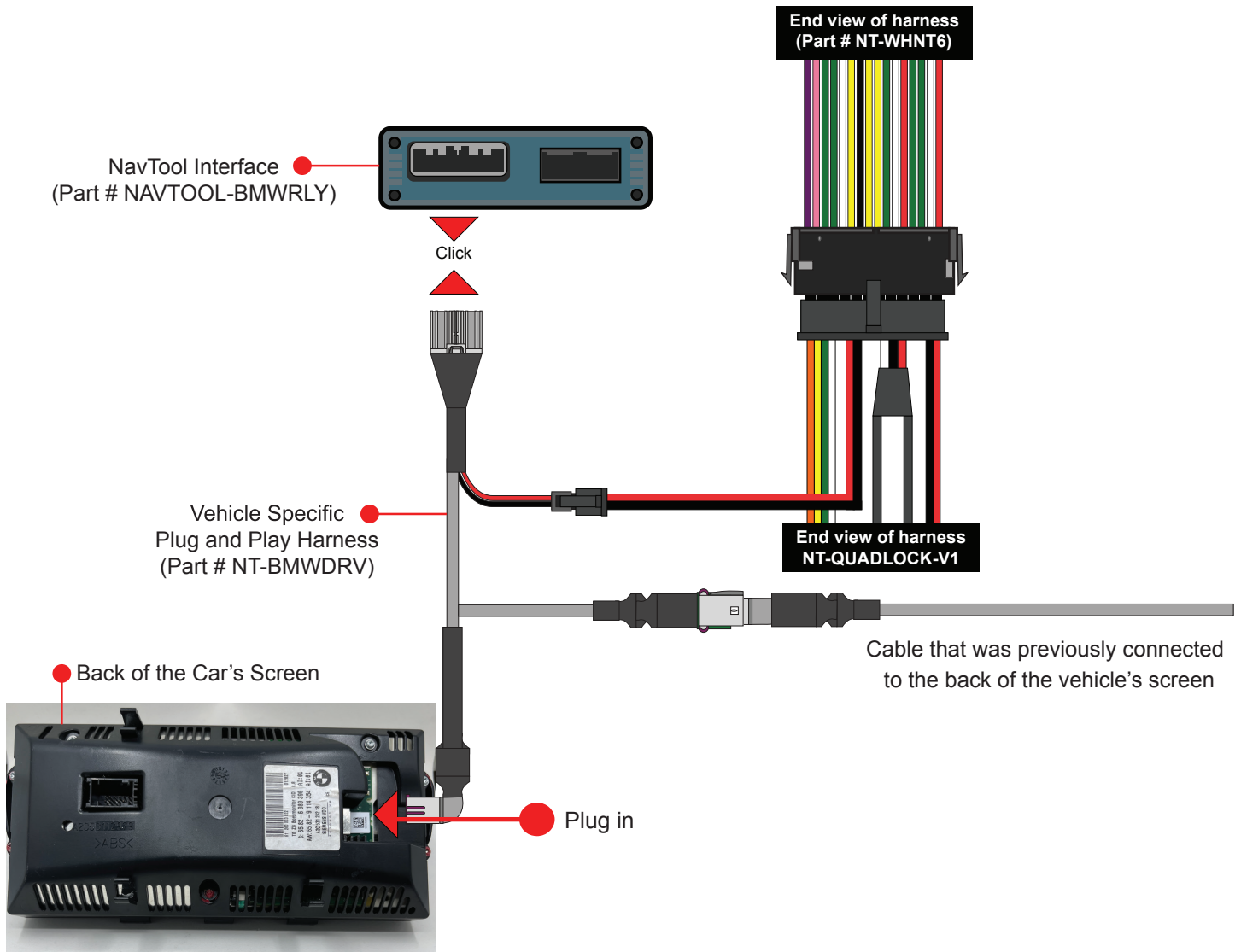

Installation Instructions

STEP 9

Step 1: Plug-in NavTool Interconnect Cable (Part # NT-EXT-BOX) into NavTool Interface (Part # NAVTOOL-BMWRLY).

Step 2: Plug-in NavTool Interconnect Cable (Part # NT-EXT-BOX) into NavTool Interface (Part # NAVTOOL6.0-LB0-NBT).

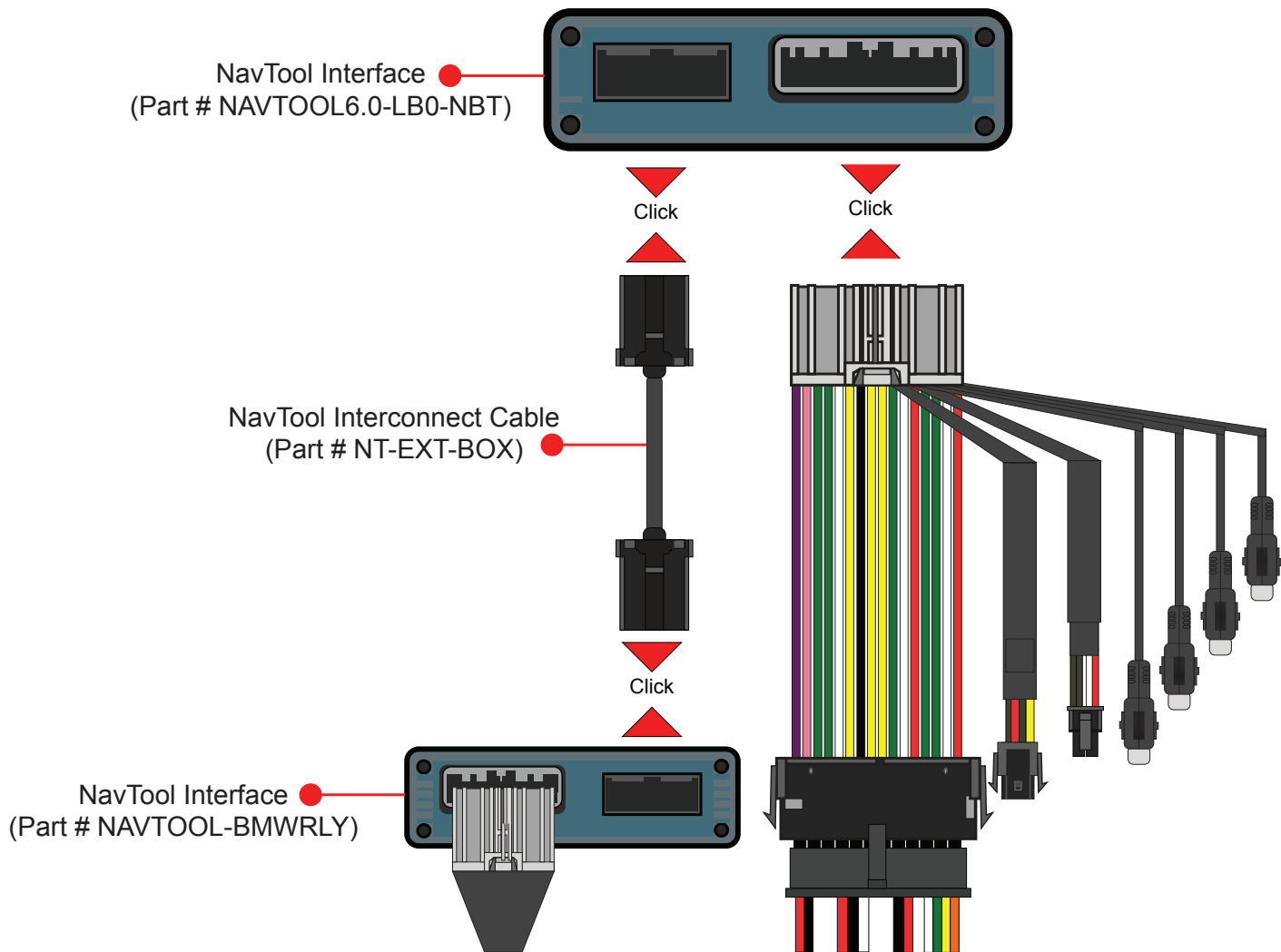

Installation Instructions

STEP 10

Step 1: Plug-in the RCAs from Vehicle Specific Plug and Play Harness (Part # NT-QUADLOCK-V1) into the AUX port of the vehicle using supplied AUX cable (Part # NT-AUX-35).

The product installation is now complete. Do not reassemble the vehicle until testing is fully complete. After you have tested that everything is working, you reassemble the vehicle. If you are adding side or front cameras, install them and plug them into the appropriate camera RCAs. If you are installing any HDMI or streaming devices, connect them to the HDMI port of the NavTool.

Note: If your vehicle is not equipped with AUX input, there is a way to retrofit your vehicle with AUX, contact us for more details

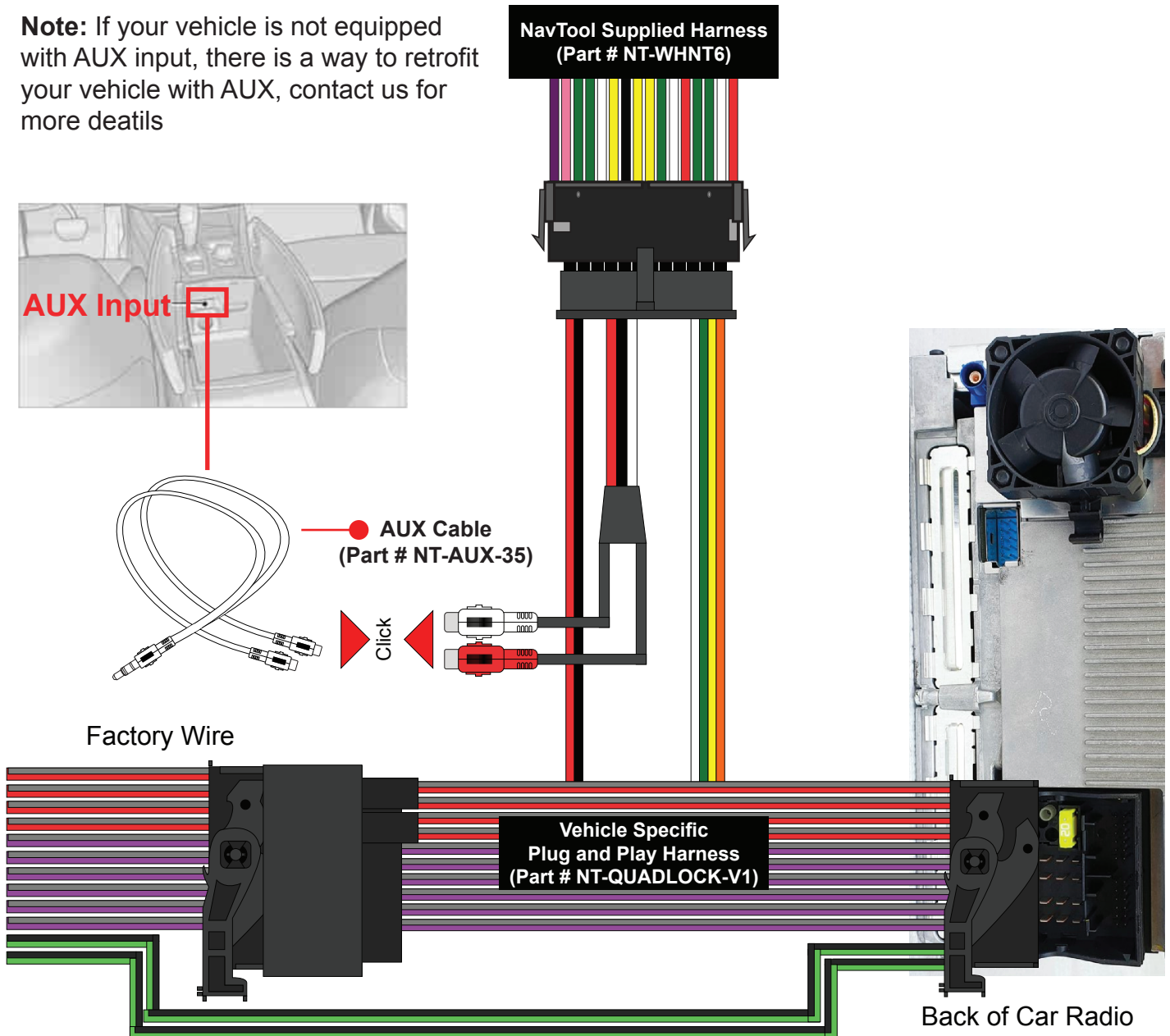

Testing and Settings

STEP 1

- Start the car, observe NavTool LED lights should be one blinking blue and two steady lit green LED lights.

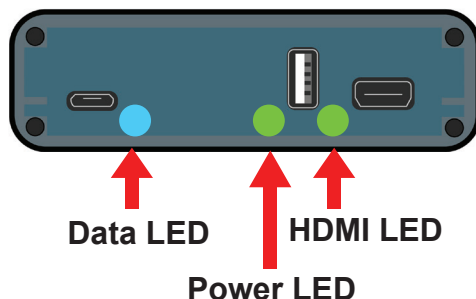

- At this time, your car radio should boot up into its initial state, and the radio should be working. Please check that the radio operates appropriately. All radio functions are working, including CD, Satellite Radio, AM/FM radio, audio plays from car speakers, and all other radio features.

Note: If your vehicle is not equipped with AUX input, there is a way to retrofit your vehicle with AUX, contact us for more details



Set Radio to AUX Audio Input:

- Pull the joystick back towards the rear seat to select the Entertainment menu.
 - Rotate the factory joystick remote to the right and select AUX.
 - Press enter on the joystick to set the audio to AUX.
- Audio will not play through car speakers if AUX input is not connected or radio is not set to AUX input.

Testing and Settings

STEP 2

- On the factory joystick remote (Fig. 1), press and hold the menu button for 3-5 seconds. The interface should emit a chirp and the interface menu (Fig. 2) should appear on the screen.



Fig. 1



Fig. 2

STEP 3

Adjust camera inputs if you haven't done so already during the initial configuration of the interface.



- Press menu button on the remote control to reveal NavTool menu bar.
- Rotate joystick to the right to highlight menu option.
- The menu option is the last icon on the right.
- Then press enter on the joystick remote to enter settings.

Step: 1



- Rotate joystick remote to highlight the settings gear.
- The settings gear is the top icon.
- Then press enter on the joystick remote to enter settings.

Step: 2

MISCELLANEOUS SETTINGS	ON	OFF
APPLE CARPLAY / ANDROID AUTO (AUTO ON MODE)	<input checked="" type="radio"/>	<input type="radio"/>
INTERFACE AUDIO SOUND	<input checked="" type="radio"/>	<input type="radio"/>
MANUAL ACTIVATION WIRE AS REVERSE TRIGGER +12V	<input type="radio"/>	<input checked="" type="radio"/>
	SAVE	CANCEL

- Rotate joystick to highlight Manual Activation Wire as Reverse Trigger +12V.
- Then press enter button on the joystick remote to change the setting to OFF, once the red dot is set to OFF (image shown on the left), rotate the joystick to highlight SAVE button and press the enter button on the joystick remote to SAVE.

Step: 3

Testing and Settings

STEP 4



Camera Settings

Rotate joystick to select the Camera Settings option then press enter button on joystick to enter this option.

Step: 1

INPUTS	FACTORY CAMERA	VIDEO INPUT	AFTERMARKET CAMERA	PARKING LINES
	<input checked="" type="radio"/>	<input type="radio"/>	<input type="radio"/>	
	<input type="radio"/>	<input checked="" type="radio"/>	<input type="radio"/>	
	<input type="radio"/>	<input checked="" type="radio"/>	<input type="radio"/>	
	<input type="radio"/>	<input checked="" type="radio"/>	<input type="radio"/>	
SAVE				CANCEL

Camera Settings

- Image above shows you typical camera settings.
- To change camera settings, rotate joystick to highlight the input on the left, once you highlighted desired camera input (rear, front, left, or right), then press enter on the joystick remote to change the option for particular camera input.
- Once the selected option is highlighted, rotate joystick to another camera input.
- Once all camera inputs are set, rotate joystick to highlight SAVE button then press enter on the joystick remote to save options.

Step: 2



Set vehicle in reverse gear to test operation of the factory rear view camera.



Press and hold menu button on the factory joystick remote to exit the interface back into the factory screen.

(The remainder of this page is intentionally left blank)

Testing and Settings

STEP 5

- Test HDMI input if you are connecting any HDMI video source.
- Press the menu button on the factory joystick remote to reveal bottom NavTool menu bar.



- Rotate joystick to the right to select HDMI input, press enter on the joystick to enter HDMI mode.
- Video signal from your HDMI source will appear on the screen. If no video source is connected or the connected source is not correctly working, you will see this message.

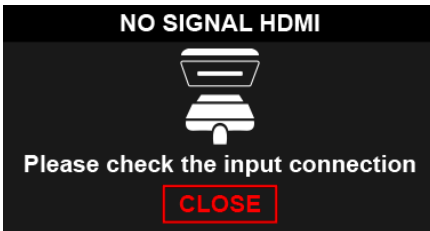

- Test AV inputs by selecting them in the menu of the interface or if you are installing any aftermarket cameras.
- To test aftermarket front camera, put the car in reverse then into drive. Front camera should display on the screen.
- To test aftermarket left and right cameras, use left and right turn signals. Left and right cameras should display depending on the turn signal activated.



After everything is tested and working, reassemble the vehicle.

(The remainder of this page is intentionally left blank)

Vehicle Reassembly Checklist

When performing vehicle reassembly, please make sure to go over the list and checkoff check mark boxes:

- Check to see if all connectors behind the screen, radio, HVAC etc. were reconnected.
- Check that LCD screen shuts off with the key off, and turns back on with the key on.
- Check touchscreen operation.
- Check Heat and AC controls operation.
- Check AM/FM/SAT radio reception.
- Check CD player/changer operation.
- Check GPS signal reception.
- Check cigarette lighter or +12V power source for accessory or constant power.
- Check to see if any other panels that were removed during installation and now being reassembled have all and any electrical connectors reconnected.
- Turn on parking light and check all dashboard lights operation.
- Check all panels for proper fit, make sure no gaps in panels are left behind.

If all steps above are checked off, you will save time, money and have an extremely happy customer.

All above steps eliminate any unnecessary customer comebacks to your shop.

If you require any further assistance please call our tech support line, email or go online

WWW.NAVTOOL.COM

1-877-628-8665

techsupport@navtool.com

How to Connect Rear Screens to Car With AV Input



Car Monitor

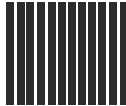

NavTool Interface



HDMI to AV Adaptor



1 in 2 Out HDMI Splitter



HDMI Sources

How to Connect Rear Screens to Car With HDMI Input



Car Monitor

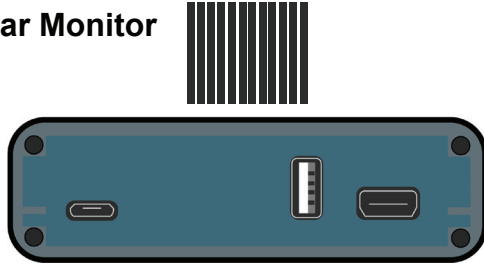

NavTool Interface



Car HDMI Input



1 in 2 Out HDMI Splitter



HDMI Sources

User Manual For Consumer

Thank you for purchasing NavTool. If you have any questions, please call toll-free at 877-628-8665.

The color/navigation screen will display a factory image when you first start your vehicle.

- Set the radio to AUX input to hear sound from the HDMI device you connected to NavTool interface. Audio will play via AUX input of the radio. **See page C2 for details.**
- How to activate: To activate/turn ON the interface, press and hold the menu button on the factory joystick. **See page C3 for the joystick controller operation buttons.**
- Rotate the joystick left or right to select the desired menu, then press the enter button to select the menu option. **See page C3 for the joystick controller operation buttons.**

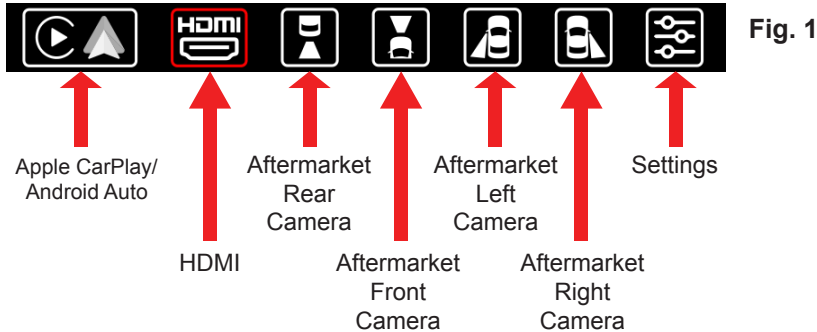

Press enter while the HDMI input is highlighted and you will enter the HDMI mode

- Video signal from your HDMI source will appear on the screen. If no video source is connected or the connected source is not correctly working, you will see this message.

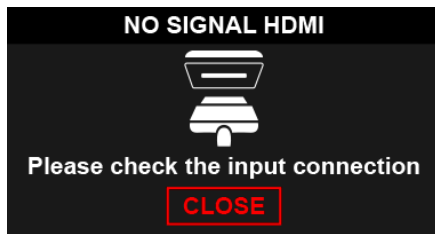

How to exit video inputs: To leave HDMI or any camera inputs, press the menu button on the factory joystick. See page C3 for details.

Aftermarket Camera Operation: The factory rearview camera will continue to work in reverse. If you installed a forward-facing camera, you could manually select it in the menu, or it will automatically display up to 10 miles per hour on the screen. This automation will happen when you put the car into drive after reverse gear. Aftermarket left and right lane watch cameras will work with respective turn signals while driving or can be selected manually via the menu.

How to deactivate: To deactivate/turn OFF the interface, press the menu button if you are on the HDMI or camera input screen. The bottom menu will appear. Press and hold the menu button for 3-5 seconds until the interface is OFF. You will now see the factory display menu.

 After everything is tested and working, reassemble the vehicle.

Setting Radio to Auxiliary

Note: If your vehicle is not equipped with AUX input, there is a way to retrofit your vehicle with AUX, contact us for more details

Set Radio to AUX Audio Input:

- Pull the joystick back towards the rear seat to select the Entertainment menu.
 - Rotate the factory joystick remote to the right and select AUX.
 - Press enter on the joystick to set the audio to AUX.
- Audio will not play through car speakers if AUX input is not connected or radio is not set to AUX input.

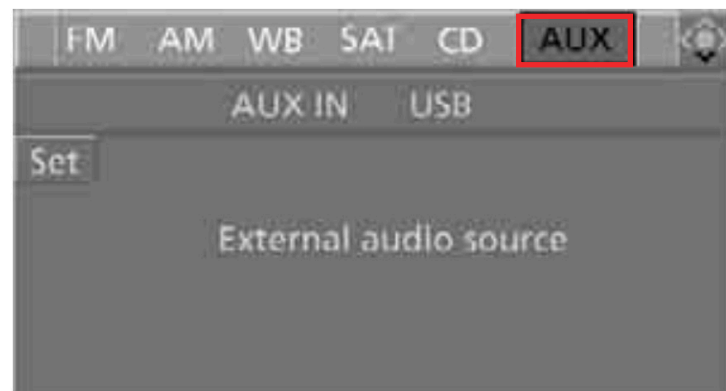
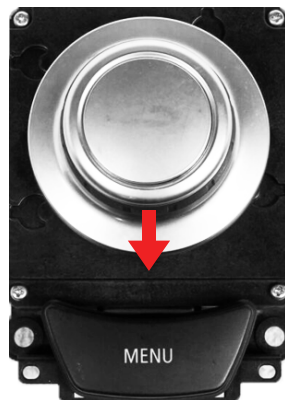

Remote Control Operation Guide



Enter- Enters into menus.

Rotate Left- Go left inside NavTool menu.

Rotate Right- Go right inside NavTool menu.

Menu- Click once to go back when on HDMI or Camera Inputs.

Press and hold for 3-5 seconds to turn the interface ON when on the car's factory screen.

Press and hold again for 3-5 seconds to activate NavTool interface.

Press and hold again for 3-5 seconds to turn the NavTool interface OFF .